

Methods for calculating the emissions of transport in the Netherlands

2017

Task Force on Transportation of the Dutch Pollutant Release and Transfer Register:

John Klein	Statistics Netherlands
Hermine Molnár-in 't Veld	Statistics Netherlands
Gerben Geilenkirchen	PBL Netherlands Environmental Assessment Agency
Jan Hulskotte	TNO
Norbert Ligterink	TNO
Stijn Dellaert	TNO
Riekele de Boer	RWS Centre for Transport and Navigation (WVL)

Colophon

Methods for calculating the emissions of transport in the Netherlands. 2017

Statistics Netherlands
PBL Netherlands Environmental Assessment Agency
TNO
RWS Centre for Transport and Navigation (WVL)

Contact:

John Klein, jken@cbs.nl

Authors:

John Klein, Jan Hulskotte, Norbert Ligterink, Stijn Dellaert, Hermine Molnár, Gerben Geilenkirchen

The majority of the tables accompanying this report have been included in a separate Excel file. References to these tables are printed in italics. In addition to the data for the emission calculation, the tables also contain references and hyperlinks to the underlying data sources and data used for the calculation of the emission totals.

Table of contents

1	Introduction	5
1.1	Source categories within mobile sources	5
1.2	Reporting requirements and formats.....	6
1.3	Outline of the report	8
1.4	Uncertainties	8
1.5	General QA/QC program in the PRTR.....	8
2	Greenhouse gas emissions.....	10
2.1	Sources category description	10
2.2	Methodological issues	11
2.2.1	Civil aviation	11
2.2.2	Road transportation	12
2.2.3	Railways.....	14
2.2.4	Water-borne navigation and fishing	14
2.2.5	Non-road mobile machinery	14
2.2.6	Military	15
2.2.7	Bunker fuels.....	15
2.3	Uncertainties and time series consistency	15
3	Road Transport	16
3.1	Source category description	16
3.2	Emissions processes and calculation methods.....	16
3.2.1	Technology dependant exhaust emissions	16
3.2.2	Fuel dependant exhaust emissions	18
3.2.3	Exhaust emissions of VOC and PAH species	18
3.2.4	Evaporative emissions of VOC and VOC components.....	19
3.2.5	PM emissions resulting from wear of tyres, brakes and road surfaces	20
3.2.6	Leakage of lubricant oil; heavy metals and PAHs.....	23
3.2.7	Consumption of lubricant oil; heavy metals.....	24
3.2.8	Fuel sold emissions from road transport.....	25
3.3	Activity data for road transport.....	25
3.4	(Implied) Emission Factors for road transport.....	28
3.4.1	VERSIT+ emission factors for air pollutants.....	28
3.4.2	Fuel consumption and fuel related emission factors	32
3.4.3	Other emission factors	33
3.4.4	VOC species profiles	33
3.4.5	Emission factors for motorcycles and mopeds	35
3.5	Uncertainties	35
3.5.1	Uncertainties in activity data.....	35
3.5.2	Uncertainties in emission factors	36
3.6	Points for improvement	37
4	Railways	38
4.1	Source category description	38
4.2	Activity data and (implied) emission factors	38
4.2.1	Exhaust emissions from railways.....	38
4.2.2	PM ₁₀ and heavy metals due to wear of overhead contact lines and carbon brushes	39
4.3	Uncertainties	39

4.4	Points for improvement	39
5	Inland navigation	40
5.1	Source category description	40
5.2	Activity data and (implied) emission factors	41
5.2.1	Professional inland shipping.....	41
5.2.2	Passenger ships and recreational craft	44
5.2.3	De-gassing cargo fumes to the atmosphere.....	45
5.3	Uncertainties	45
5.4	Points for improvement	45
6	Fisheries	47
6.1	Source category description	47
6.2	Activity data and (implied) emission factors	47
6.3	Uncertainties	48
6.4	Points for improvement	48
7	Maritime navigation.....	49
7.1	Source category description	49
7.2	Activity data and (implied) emission factors	49
7.2.1	Emissions of sailing sea-ships	50
7.2.2	Emissions from seagoing vessels at berth	52
7.2.3	Exhaust emissions of SO ₂ , N ₂ O, NH ₃ , heavy metals and VOC/PAH components	53
7.3	Uncertainties	54
7.4	Points for improvement	54
8	Civil aviation.....	55
8.1	Source category description	55
8.2	Activity data and (implied) emission factors	55
8.2.1	Exhaust emissions at Amsterdam Airport Schiphol.....	56
8.2.2	Emissions from tyre and brake wear	57
8.2.3	Emissions from auxiliary power units.....	58
8.2.4	Emissions from ground support equipment.....	58
8.2.5	Emissions from storage and transfer of jet fuel	59
8.3	Uncertainties	59
8.4	Points for improvement	60
9	Non-Road Mobile Machinery.....	61
9.1	Source category description	61
9.2	Activity data and (implied) emission factors	61
9.2.1	Activity data.....	61
9.2.2	Emission Factors	62
9.2.3	Mobile machinery at container terminals.....	63
9.3	Uncertainties	63
9.4	Points for improvement	64
10	REFERENCES	65
11	APPENDIX: Quality codes	71

1 Introduction

The sources that cause emissions of environmental pollutants can roughly be divided into stationary and mobile sources. Examples of stationary sources are installations for generating heat and energy, such as central heating systems and electrical power plants, and installations where industrial processes take place. Mobile sources include various means of transport such as passenger cars, heavy-duty trucks, inland waterway vessels and aircraft, as well as mobile machinery with combustion engines, such as agricultural tractors and forklifts.

This report describes the methodologies, emission factors and relevant activity data used to calculate the emissions of environmental pollutants from mobile sources in the Netherlands. These emissions are calculated annually by the Task Force on Transportation of the Dutch Pollutant Release and Transfer Register (PRTR). The resulting greenhouse gases emissions are reported annually in the National Inventory Report, whereas the air polluting emissions are reported in the Informative Inventory Report. Both inventory reports give a brief description of the trends in emissions and the methodologies used to calculate emissions. The methodologies and underlying data used are described in more detail in the present report.

The current report describes the methodologies used for calculating the emissions for the 1990-2015 time series, as reported in the 2017 National Inventory Report (Coenen et al. 2017) and the 2017 Informative Inventory Report (Jimmink et al. 2017). The report has been compiled by the members of the Task Force on Transportation of the PRTR, which includes members of Statistics Netherlands, the PBL Netherlands Environmental Assessment Agency, the Netherlands Organisation of Applied Scientific Research TNO and the RWS Centre for Transport and Navigation (WVL) of the Dutch Ministry of Infrastructure and the Environment. For a more general description of the Dutch PRTR and the different task forces, please refer to the website of the PRTR (www.emissieregistratie.nl).

The majority of the tables accompanying this report have been included in a separate Excel file. References to these tables are printed in italics. In addition to the data for the emission calculation, the tables also contain references and hyperlinks to the underlying data sources and data used for the calculation of the emission totals.

1.1 Source categories within mobile sources

This report covers the methodologies used for calculating both the greenhouse gas emissions and the emissions of air pollutants by mobile sources in the Netherlands. Mobile sources include:

- Road transportation
- Railways
- Civil aviation
- Inland navigation
- Maritime navigation
- Fisheries
- Non-Road Mobile Machinery
- Military shipping and aviation

For each source category, various processes are distinguished that result in emissions of greenhouse gases and air pollutants:

- Combustion of motor fuels for propulsion;
- Evaporation of motor fuels from the fuel system of vehicles;
- Wear of tyres, brake linings and road surfaces;

- Leakage and consumption of motor oil;
- Wear of overhead contact lines and carbon brushes on trains, trams and metros;
- Support processes on board ships (heating, electricity generation, refrigeration and pumping).

The present report only covers emissions to air. The emissions to water from mobile sources are calculated by the MEWAT taskforce of the PRTR. This includes emissions to water from:

- Anti-fouling on recreational boats;
- Coatings and bilge water from inland waterway vessels;
- Leakage of propeller shaft grease and spillage from inland waterway vessels;
- Corrosion of zinc anodes on inland waterway vessels and locks;
- Leaching from seagoing vessels and fishery vessels in harbours and national continental shelf;
- Anodes of seagoing vessels and fishery vessels in harbours and on the national continental shelf.

For more information about the methodologies, activity data and emission factors used to calculate the emissions from the above mentioned emission sources, please refer to the documentation on the PRTR-website.

1.2 Reporting requirements and formats

The emissions from the PRTR are used for air quality modelling and for emission reporting to the UN and the EU. Under the UN Framework Climate Change Convention (UNFCCC) and the EU Monitoring Mechanism Regulation (MMR), countries are obliged to annually report national emissions of greenhouse gases. The emissions of air pollutants are reported under the UNECE Convention on Long-Range Transboundary Air Pollution (LRTAP) and the EU National Emission Ceilings Directive (NECD).

The reporting guidelines and formats for these reporting obligations differ. The present report covers the methodologies used for both reporting obligations. Greenhouse gas emissions are reported in the annual National Inventory Report (NIR) and the accompanying 'Common Reporting Format' (CRF) tables, based on the reporting obligations and guidelines from the 2006 IPCC Guidelines (IPCC 2006). Activity data for calculating the emissions is for the most part derived from the national Energy Balance, as reported annually by Statistics Netherlands. Emissions from air pollutants are reported in the Informative Inventory Report (IIR) and the accompanying tables, using the 'Nomenclature For Reporting' (NFR) and the UNECE Guidelines for reporting emissions and projections data under the LRTAP convention (UNECE 2015). The CRF and NFR codes used to report emissions for the different source categories are mentioned in the different chapters of the present report.

The emission estimates for mobile sources are also used for air quality monitoring in the Netherlands. For these purposes, emissions are estimated for the Dutch national territory. Where methodologies for calculating emissions on national territory differ from methodologies used to calculate official greenhouse gas (CRF) and air pollutant (NFR) emissions in the Netherlands, this is described in the different chapters. Table 1A gives a short overview of the emissions included in the different reporting obligations.

For *civil aviation*, the CRF only includes greenhouse gas emissions from domestic aviation, i.e. all flights that both depart and arrive in the Netherlands. Emissions from international aviation, with either departure or arrival abroad, are reported as a memo item and are not included in the national totals. Emissions are calculated based on the amount of fuel supplied to either national or international aviation. The NFR includes emissions from both national and international aviation, but only throughout the Landing and Take-off cycle (LTO). Cruise emissions are not included in the national totals. Air quality modelling also uses the LTO-emissions from air pollutants by civil aviation that are reported in the NFR.

For *road transport* and for *railways*, both the CRF and the NFR include emissions resulting from the fuel supplied to either road transport or railways in the Netherlands. The activity data for both reporting obligations are identical. Since some of this fuel is used abroad, the emission totals are not suited for air

quality modelling. Therefore, emissions from road transport for air quality modelling are derived using statistics on vehicle kilometres driven (and resulting fuel used) in the Netherlands. For railways there is no bottom-up calculation of air pollutant emissions in the Netherlands due to the lack of detailed activity data on train kilometres driven per type. Air quality modelling therefore uses the same emissions totals for railways as reported in the NFR.

Table 1A Emissions included in different reporting obligations

Source category	Greenhouse gases (CRF)	Air pollutants (NFR)	Air pollutants (air quality modelling)
Civil aviation	Domestic only; LTO & cruise International aviation included as memo item	Domestic & international; LTO only	Domestic & international; LTO only
Road Transportation	Based on <i>fuel sold</i> in NL	Based on <i>fuel sold</i> in NL	Based on <i>fuel used</i> in NL
Railways	Based on <i>fuel sold</i> in NL	Based on <i>fuel sold</i> in NL	Based on <i>fuel sold</i> in NL
Water-borne inland navigation	Domestic only	All emissions on Dutch national territory	All emissions on Dutch national territory
Non-Road Mobile Machinery	Based on <i>fuel used</i> in NL	Based on <i>fuel used</i> in NL	Based on <i>fuel used</i> in NL
Fishing	Based on <i>fuel sold</i> in NL	Based on <i>fuel sold</i> in NL	Based on <i>fuel used</i> in NL
Military aviation and shipping	Based on <i>fuel sold</i> in NL	Not included	Not included
Maritime navigation	Memo item; based on <i>fuel sold</i>	Memo item; based on <i>fuel used</i>	Based on <i>fuel used</i>

For *inland navigation*, the CRF only includes greenhouse gas emissions from domestic navigation, i.e. all voyages that both depart and arrive in the Netherlands. Emissions from international navigation, with either departure or arrival abroad, are reported as a memo item and are not included in the national totals. The NFR includes all emissions of air pollutants from inland navigation that take place on Dutch national territory, including the emissions from international navigation emitted in the Netherlands. The NFR emission totals are also used for air quality modelling.

For *fisheries*, both the CRF and the NFR include emissions resulting from the fuel delivered to fisheries in the Netherlands. Since some of these deliveries take place at sea, not all emissions resulting from these fuel deliveries take place on Dutch national territory. Specifically for air quality modelling, estimates are made of air pollutant emissions from fisheries on the Dutch part of the North Sea.

For *non-road mobile machinery* (NRMM), both the CRF and the NFR include emissions resulting from all fuel used by NRMM in the Netherlands. Since fuel sales to NRMM are not reported separately in the Energy Balance, fuel consumption is estimated using a modelling approach. To ensure consistency with national energy statistics, the total fuel sales data from the Energy Balance are adjusted accordingly. Emission totals from the NFR are also used for air quality modelling.

Emissions from *maritime navigation* are reported as a memo item in both the CRF and the NFR, but the activity data differs between both reporting obligations. The CRF includes total fuel sold (and resulting emissions) to maritime navigation in the Netherlands, regardless of where the fuel is subsequently used. The NFR includes the emissions of air pollutants by maritime shipping on the Dutch part of the North Sea, regardless of whether or not the fuel used was delivered in the Netherlands or abroad. The emission estimates from the NFR are also used for air quality modelling.

Emissions from *military aviation and navigation* are included in the CRF, based on the fuel deliveries for military purposes in the Netherlands. The NFR does not include emissions from military aviation or shipping due to a lack of data on number of flights and voyages and the types of air planes and ships used. Due to this lack of emissions estimates, emissions from military aviation and shipping are also not included in air quality modelling.

1.3 Outline of the report

The current report describes the methodologies and underlying data used to estimate emissions from mobile sources in the Netherlands. Chapter two covers the methodologies used for calculating emissions of greenhouse gases by mobile sources. The remaining chapters cover the methodologies used for calculating emissions of air pollutants by the different source categories. These chapters start with a description of the specific source category and the processes that lead to emissions. This is followed by a description of the activity data and (implied) emission factors, the uncertainty estimates and the points for improvement.

The (trends in the) emission totals for the different source categories and the source-specific recalculations are described annually in the National Inventory Report (NIR) and Informative Inventory Report (IIR). The present report only covers the methodologies used. *Table 1.1* of the accompanying table set does give an overview of the share of the different mobile source categories in the national emission totals for greenhouse gases and air pollutants and in the emission totals of mobile sources. *Table 1.2* gives an overview of the annual changes in methodologies. A general description of the PRTR QA/QC program is given in paragraph 1.4. Source-specific QA/QC procedures are described in the NIR and IIR.

1.4 Uncertainties

The reporting guidelines for emissions of both greenhouse gases and air pollutants require Parties to also quantify uncertainties in their emission estimates. The uncertainty estimates for emissions from mobile sources are covered in the present report. Uncertainty estimates for greenhouse gas emissions have been quantified and are described in Chapter 2.3. For air pollutants, uncertainties cannot be quantified due to a lack of data. Instead the classification system of the US EPA is used for estimating uncertainties in activity data, emissions factors and resulting emissions of air pollutants. The classification is as follows:

- A = The data originate from extremely accurate (high precision) measurements.
- B = The data originate from accurate measurements.
- C = The data originate from a published source, such as government statistics or industrial trade figures.
- D = The data are generated by extrapolating other measured activities.
- E = The data are generated by extrapolating data from other countries.

It should be emphasized that the estimates of uncertainties are arbitrary and subjective in many cases. The uncertainties in the ultimate emission estimates are therefore only indicative. The resulting estimates are shown in the Appendix and are described in more detail in Chapter 3 through 9 covering the different source categories.

1.5 General QA/QC program in the PRTR

The annual work plan of Dutch PRTR includes a description of QA/QC processes that have to be carried out before emissions figures can be finalized. The QA/QC procedures of the PRTR focus on consistency, completeness and accuracy of the emission data. The general QA/QC for the inventory is largely performed within the PRTR as an integrated part of the working processes. Once emission data has been uploaded by the different taskforces to the PRTR database, automated checks are performed by the data exchange module (DEX) for internal and external consistency. Results are reported back to the taskforces for error checking. Several weeks before the emission data is finalized, a trend verification workshop is organized by the National Institute for Public Health and the Environment (RIVM). Results of this workshop, including actions for the taskforces to resolve the identified clarification issues, are documented at RIVM. Required changes to the database are then made by the taskforces.

Before the trend verification workshop, a snapshot from the PRTR emission database is made available to the task forces by RIVM in a web-based application (Emission Explorer, EmEx). Task forces are required to

check for level errors and consistency in the algorithm/method used for calculations throughout the time series. The task forces perform checks for relevant gases and sectors. The totals for the sectors are then compared with the previous year's data set. Where significant differences are found, the task forces evaluate the emission data in more detail. The results of these checks form the subject of discussion at the trend analysis workshop and are subsequently documented.

Furthermore, the PRTR-team provides the task forces with time series of emissions per substance for the individual emission sources. The task forces examine these time series. During the trend verification workshop the emission data are checked in two ways: emission totals for historic years are compared to previously reported emission totals and data for the most recent historic year that was added to the time series is checked with the previous years for consistency. The checks of outliers are performed on a more detailed level of the individual emission sources in all sector background tables:

- Annual changes in emissions;
- Annual changes in activity data;
- Annual changes in implied emission factors and
- Level values of implied emission factors.

Exceptional trend changes and observed outliers are noted and discussed at the trend analysis workshop, resulting in an action list. Items on this list have to be processed within 2 weeks or be dealt with in next year's inventory.

2 Greenhouse gas emissions

This chapter covers the methodologies used for calculating the greenhouse gas emissions from mobile sources in the Netherlands. Since these methodologies differ from those used for calculating emissions of air pollutants, they are covered in a separate chapter. The emissions of greenhouse gases from mobile sources in the Netherlands are reported annually in the National Inventory Report (NIR) and the accompanying 'Common Reporting Format' (CRF) tables, based on the reporting obligations and guidelines from the 2006 IPCC Guidelines (IPCC 2006).

2.1 Sources category description

The greenhouse gas emissions from mobile sources are reported under different sources categories in the CRF, as is shown in Table 2A. Emissions from transport are reported under 1A3, which includes emissions from civil aviation (1A3a), various means of road transportation (1A3b), railways (1A3c) and water-borne navigation (1A3d). Emissions from non-road mobile machinery are reported under different source categories in the CRF, based on the sectors where the machinery is applied:

- Emissions from industrial and construction machinery are reported under 1A2g;
- Emissions from commercial and institutional machinery are reported under 1A4a;
- Emissions from residential machinery are reported under 1A4b;
- Emissions from agricultural machinery are reported under 1A4c.

Emissions from fisheries are reported under 1A4c as well, whereas emissions from military aviation and shipping are reported under 1A5b. Emissions from bunker fuels, delivered to international aviation and water-borne navigation, are not part of the national emission totals, but instead are reported as a memo item under source category 1D1. Table 2A gives an overview of the methodologies used for calculating the greenhouse gas emissions, with Tier 1 (T1) being the most basic approach and Tier 3 (T3) the most detailed. The table also shows whether the emission factors used are country-specific values (CS) or default values (D) derived from the 2006 IPCC Guidelines.

Table 2A Greenhouse gas emission reporting for mobile sources in the NFR

CRF code	Source category description	Methodology	Emission factors*
1D1a	International bunkers (International Aviation)	T1	D
1D1b	International bunkers (International Navigation)	T1, T2	CS, D
1A2gvii	Manufacturing industries and construction, other (Off-road vehicles and other machinery)	T1, T2	CS, D
1A3a	Civil aviation	T1	CS, D
1A3b	Road Transportation	T2, T3	CS, D
1A3c	Railways	T1, T2	CS, D
1A3d	Water-borne navigation	T1, T2	CS, D
1A4aii	Commercial/Institutional (Off-road vehicles and other machinery)	T1, T2	CS, D
1A4bii	Residential (Off-road vehicles and other machinery)	T1, T2	CS, D
1A4cii	Agriculture/Forestry/Fishing (Off-road vehicles and other machinery)	T1, T2	CS, D
1A4ciii	Fishing	T2	CS, D
1A5b	Mobile (Military use)	T2	CS, D
2D3	Non-energy Products from Fuels and Solvent Use (Other)	T3	CS

*) CS = country-specific; D = default

Source category 1A3a (civil aviation) only includes emissions from domestic aviation in the Netherlands, i.e. all aviation with departure and arrival in the Netherlands. This includes emissions from overland flights which depart from and arrive at the same airport. Emissions from fuel deliveries to international aviation are reported under 1D1a and are not part of the national emission totals. Similarly, source category 1a3d (water-borne navigation) only includes emissions from domestic navigation. This includes among others the emissions from recreational craft, passenger and freight shipping and so-called 'work-at-sea'. Emissions from international water-borne navigation, i.e. navigation with either arrival or departure abroad, are not part of the national emission totals but are reported as a memo item under 1D1b. Emissions from fisheries are also not included under 1A3d, but are reported separately in the inventory under source category 1A4ciii. In line with the 2006 IPCC Guidelines, all emissions from fishing are part of the national emission totals; there is no international bunker fuel category for commercial fishing, regardless of where the fishing occurs.

Emissions from military aviation and water-borne navigation are also reported separately under source category 1A5b. This concerns the emissions resulting from the combustion of jet kerosene and marine fuel for military aviation and water-borne navigation. The emissions by the land forces are not reported separately but are included in the emissions by road transport and mobile machinery.

Source category 1A3b (road transportation) includes all emissions from motorized road transport in the Netherlands. This includes emissions from passenger cars (1A3bi), light-duty trucks (1A3bii), heavy-duty trucks and buses (1A3biii) and motorcycles and mopeds (1A3biv). It also includes CO₂ emissions from the use of lubricants by two-stroke mopeds and motorcycles. CO₂ emissions resulting from the use of urea-based additives in catalytic converters in road vehicles are reported under source category 2D3. Source category 1A3c (Railways) includes greenhouse gas emissions from diesel fuelled railway transportation in the Netherlands.

2.2 Methodological issues

Greenhouse gas emissions from mobile sources in the Netherlands are calculated based on the formula:

$$\text{Emission (kg)} = \sum \text{type of fuel} \text{fuel sales (kg)} * \text{heating value (MJ/kg)} * \text{Emission factor (kg/MJ)}$$

The activity data (i.e. the fuel sales per fuel type) are for the most part derived from the Energy Balance, as reported by Statistics Netherlands. *Table 2.1* shows the activity data used for the most recent inventory. The heating values and the CO₂-emission factors per fuel type are country-specific and derived from the Netherlands' list of fuels (Zijlema 2017), as shown in *Table 2.2*. The N₂O and CH₄ emission factors for the most part are defaults, the only exception being the emission factors for road transport, as is described in more detail below.

2.2.1 Civil aviation

Greenhouse gas emissions from domestic civil aviation are calculated using a fuel-based Tier 1 methodology. Fuel deliveries for domestic aviation are derived from the Energy Balance. This includes deliveries of both jet kerosene and aviation gasoline. The time-series for deliveries of both jet kerosene and aviation gasoline for domestic aviation are shown in *Table 2.1*.

The heating values and CO₂ emission factors for aviation gasoline and jet kerosene are derived from the Netherlands' list of fuels (Zijlema 2017). For aviation gasoline country-specific values are used, identical to those for gasoline use for road transport, whereas for jet kerosene default values are used from the 2006 IPCC Guidelines (IPCC 2006). These values are shown in *Table 2.2A*. For N₂O and CH₄ default emission factors are used as well. These emissions factors are shown in *Table 2.2B*. Since civil aviation is a minor source of greenhouse gas emissions in the Netherlands and is not a key source in the inventory, the use of a Tier 1 methodology to estimate emissions is deemed sufficient.

Emissions of precursor gases (NO_x, CO, NMVOC and SO₂), reported in the CRF under ‘domestic aviation’, are the uncorrected emission values from the Netherlands Pollutant Release and Transfer Register and refer to aircraft emissions during landing and take-off (LTO) cycles at all Dutch airports. The methodology used to calculate LTO-emissions of air pollutants is described in detail in chapter 6. No attempt has been made to estimate non-greenhouse gas emissions specifically related to domestic flights (including cruise emissions of these flights), since these emissions are negligible.

2.2.2 Road transportation

According to the 2006 IPCC Guidelines, greenhouse gas emissions from road transport should be attributed to the country where the fuel is sold. Total fuel consumption by road transport therefore should reflect the amount of fuel sold within the country’s territory. To comply with this, activity data for greenhouse gas emissions from road transport are derived from the Energy Balance. This includes fuel sales of gasoline, diesel, Liquefied Petroleum Gas (LPG), natural gas (CNG) and biofuels, as is shown in *Table 2.1*. Fuel sales data for gasoline from the Energy Balance are adjusted for the use of gasoline in recreational craft, which is not reported separately in the Energy Balance but instead is included in road transport (see also paragraph 2.2.4).

Fuel sales data in the Energy Balance are not divided according to vehicle categories. For emission reporting, total sales per fuel type are disaggregated to the various road transport subcategories in accordance with their share in total fuel consumption in the Netherlands, as calculated bottom-up using vehicle kilometres travelled per vehicle type and the specific fuel consumption per vehicle kilometre. This bottom-up calculation of fuel consumption by road transport in the Netherlands is described in more detail in Section 3.3 and 3.4. The resulting fuel consumption figures differ from fuel sales data due to varying reasons:

- Stockpiling is included in fuel sales data;
- Both approaches (fuel consumption and fuel sales) contain statistical inaccuracies;
- Cross-border refuelling. This concerns fuel purchased in the Netherlands (included in sales) that is used abroad (not included in consumption) or fuel purchased abroad (not included in sales) that is used in the Netherlands (included in consumption).

This results in annual differences between fuel sales per fuel type and fuel consumption as calculated bottom up. Due to the nature of the differences (such as cross-border refuelling and stockpiling), the difference between fuel consumption and fuel sales differs from year to year. In calculating greenhouse gas emissions from road transport, the fuel sales data are used to calculate total emissions, whereas the fuel consumption data is only used to split sales per fuel type to different vehicle categories.

The CO₂ emissions from road transport are calculated using a Tier 2 methodology. Country-specific heating values and CO₂ emission factors are derived from the Netherlands’ list of fuels (Zijlema 2017), as shown in *Table 2.2A*. N₂O and CH₄ emissions from road transport are dependant not only on the fuel type, but also on the combustion and emission control technology and the operating conditions of the vehicles. Emissions of N₂O and CH₄ from road transport therefore are calculated using a Tier 3 methodology, based on vehicle kilometres travelled on Dutch territory and technology-specific emission factors, expressed in grams per vehicle kilometre travelled. In this bottom-up approach, vehicle types are distinguished according to:

- Vehicle type, e.g. passenger cars, light-duty trucks, heavy-duty trucks and buses;
- Fuel type, e.g. gasoline, diesel, LPG and natural gas;
- Emission control technology, as a function of the different Euro standards per fuel type for pollutant emissions;
- Operating conditions, using different emission factors for urban driving, rural driving and highway driving and the degree of congestion per road type.

The different vehicle categories used in the emission calculation are shown in *Table 3.1*. The activity data used for the bottom-up approach is derived from Statistics Netherlands and is described in more detail in Chapter 3.3.

CO₂ emissions from the use of lubricants in two-stroke engines in motorcycles and mopeds are estimated based on the amount of fuel (gasoline) used. It is assumed that 1 kilogramme of lubricants is used for every 50 kilogram of gasoline. CO₂ emissions are calculated assuming full (100%) oxidation of the lubricants and using default CO₂ emission factors.

N₂O is primarily emitted by petrol and LPG vehicles equipped with three-way catalysts. Most emissions result from the cold start, when the catalyst is not yet warmed-up. The country-specific emissions factors for N₂O are derived from Kuiper & Hensema (2012). For older vehicle types, emission factors are derived from national emission measurement programmes (Gense and Vermeulen, 2002 & Riemersma et al., 2003). For recent generations of road vehicles with new emission reduction technologies, emission factors are derived from the 2013 EEA Emission Inventory Guidebook. The N₂O emission factors per vehicle type and road type are shown in *Table 3.16*.

CH₄ emissions from road transport are derived from total VOC emissions using VOC species profiles. The country-specific VOC emission factors for the different vehicle categories are shown in *Table 3.30* and for the most part are derived from the VERSIT+ emission factor model. The VERSIT+ model and resulting emissions factors are described in more detail in Chapter 3.4. The mass fraction of CH₄ in total VOC emissions is dependent on the fuel type, vehicle type and – for petrol vehicles – whether or not the vehicle is equipped with a three-way catalyst. Petrol-fuelled vehicles equipped with a catalyst emit more CH₄ per unit of VOC than vehicles without a catalyst. In absolute terms, however, passenger cars with catalysts emit far less CH₄ than passenger cars without a catalyst because total VOC emissions are far lower. The country-specific VOC species profiles used to derive CH₄ emissions from total VOC emission are shown in *Table 3.27*.

To make sure CH₄ and N₂O emissions from road transport are consistent with fuel sales data, the bottom-up approach described above is used to calculate fleet average CH₄ and N₂O emission factors per unit of fuel used. These emission factors are consequently combined with the fuel sales data from the Energy Balance, as shown in *Table 2.1*, to calculate total CH₄ and N₂O emissions from road transport.

Emissions resulting from the use of biofuels in road transport are reported separately in the CRF. CO₂ emissions from biofuels are reported as a memo item and are not part of the national emission totals. CH₄ and N₂O emissions from biofuels are included in the national emission totals. The emission calculation for biofuels is comparable to that for fossil fuels and is based on sales data for biodiesel and ethanol, as derived from the Energy Balance (see also *Table 2.1*). Emissions of CH₄ and N₂O from biodiesel and ethanol are calculated using the same emission factors as used for fossil diesel and gasoline, respectively.

Table 2.3 gives an overview of the specific weight, net heating values and (implied) CO₂, N₂O and CH₄ emissions factors used for road transport throughout the time-series.

CO₂ emissions from urea-based catalysts

CO₂ emissions from urea-based catalysts are estimated using a Tier 3 methodology using country-specific CO₂ emission factors for different vehicle types. Selective Catalytic Reduction (SCR) technology has been applied in diesel-fuelled heavy-duty vehicles since 2005 for reduction of NO_x emissions. To estimate the CO₂ emissions from urea-based catalysts, TNO carried out a study commissioned by the Dutch PRTR to estimate road type specific CO₂ emission factors from the use of urea-additives. The resulting emission factors are shown in *Table 2.4*. The use of urea-additive (AdBlue) was estimated as a percentage of diesel fuel consumption of 6% for Euro V engines and 3% for Euro VI engines. *Table 2.5* shows the resulting estimates of urea use throughout the time series. Urea-additive CO₂ emissions are calculated to be 0.6% or less of the diesel fuel CO₂ emissions for Euro V engines and 0.3% or less for Euro VI engines. The methodology used is described in more detail in Stelwagen & Ligterink (2014).

2.2.3 Railways

Fuel sales to railways in the Netherlands are derived from the Energy Balance, as shown in *Table 2.1*. Since 2010, Statistics Netherlands derives fuel sales data from Vivens, a recently founded co-operation of rail transport companies that purchases diesel fuel for the railway sector in the Netherlands. Before 2010, diesel fuel sales to the railway sector were obtained from Dutch Railways (NS). NS used to be responsible for the purchases of diesel fuel for the entire railway sector in the Netherlands.

CO₂ emissions from railways are calculated using a Tier 2 methodology, based on fuel sales data and country-specific CO₂ emission factors, as shown in *Table 2.2A*. Due to a lack of country-specific CH₄ and N₂O emission factors for railways, CH₄ and N₂O emissions are estimated using a Tier 1 methodology, using default emission factors derived from the 2013 EEA Emission Inventory Guidebook (EEA 2013). The Guidebook provides emission factors for N₂O (24 g/tonne fuel) and CH₄ (182 g/tonne fuel). The resulting emission factors per megajoule for Railways are shown in *Table 2.2B*. Emissions from railways are not a key source in the inventory, so the use of Tier 1 and Tier 2 methodologies is deemed sufficient.

2.2.4 Water-borne navigation and fishing

Diesel fuel consumption for domestic inland navigation is derived from the Energy Balance. Gasoline fuel consumption for recreational craft is not reported separately in the Energy Balance, but is included under road transport. In order to calculate greenhouse gas emissions from gasoline fuel consumption by recreational craft, fuel consumption is estimated annually using a bottom-up approach as described in NNWB (2008). Gasoline fuel sales data for road transport, as derived from the Energy Balance, are corrected accordingly.

The CO₂ emissions from water-borne navigation are calculated using a Tier 2 methodology. Country-specific heating values and CO₂ emission factors for gasoline and diesel are derived from the Netherlands' list of fuels (Zijlema 2017), as shown in *Table 2.2A*.

CH₄ and N₂O emissions from domestic water-borne navigation are derived using a Tier 1 methodology. Neither the 2006 IPCC Guidelines nor the EEA Emission Inventory Guidebook provides specific N₂O and CH₄ emission factors for inland shipping. The Tier 1 default CH₄ and N₂O emission factors from the 2006 IPCC Guidelines actually apply to diesel engines using heavy fuel oil. Since no emission factors are provided for diesel engines using diesel oil, the emission factors for heavy fuel oil are used in the inventory for diesel oil as well. N₂O and CH₄ emission factors for gasoline use by recreational craft are not provided in either the Emission Inventory Guidebook or the IPCC Guidelines. Emission factors are therefore derived from gasoline use in non-road mobile machinery, as provided by the 2013 Emission Inventory Guidebook (EEA 2013). The resulting emission factors for N₂O and CH₄ for inland navigation and recreational craft are shown in *Table 2.2B*.

Fuel deliveries to national fishing are also derived from the national Energy Balance, as shown in *Table 2.1*. In line with the 2006 IPCC Guidelines, all emissions from fishing are part of the national emission totals; there is no international bunker fuel category for commercial fishing, regardless of where the fishing occurs. The CO₂ emissions from fisheries are calculated using a Tier 2 methodology. Country-specific heating values and CO₂ emission factors for diesel oil and heavy fuel oil are derived from the Netherlands' list of fuels (Zijlema 2017), as shown in *Table 2.2A*. CH₄ and N₂O emissions from fisheries are derived using a Tier 1 methodology. The emission factors are shown in *Table 2.2B* and are derived from the 2006 IPCC Guidelines.

2.2.5 Non-road mobile machinery

Fuel consumption by non-road mobile machinery (NRMM) in different economic sectors is not reported separately in the Energy Balance. Therefore, fuel consumption and resulting emissions from NRMM are calculated using a modelling approach. The EMMA model (Hulskotte & Verbeek 2009) uses sales data and survival rates for different types of machinery to estimate the active fleet. Combined with assumptions on

the average use (annual operating hours) and the fuel consumption per hour of operation for the different types of machinery, total fuel consumption of NRMM is estimated. The methodology of the EMMA model is similar to the methodology used in the EPA NON-ROAD USA model by the US Environmental Protection Agency (EPA), as described in Harvey et al. (2003). The methodology to estimate fuel consumption from NRMM is described in detail in Chapter 8.

CO₂ emissions from NRMM are estimated using a Tier 2 methodology. Country-specific heating values and CO₂ emission factors are derived from the Netherlands' list of fuels (Zijlema 2017), as shown in *Table 2.2A*. CH₄ and N₂O emissions from NRMM are estimated using a Tier 1 methodology, using emission factors derived from the 2013 EEA Emission Inventory Guidebook, as shown in *Table 2.2B*.

2.2.6 Military

The jet fuel deliveries for military aircraft in the Netherlands are derived from the Energy Balance. This includes all fuel delivered for military aviation purposes within the Netherlands, including fuel deliveries to militaries of external countries. Deliveries of marine diesel oil for military purposes are not reported separately in the Energy Balance and therefore are derived directly from the Ministry of Defence. These deliveries include all fuel deliveries to the Dutch Navy within the Netherlands and abroad. The fuel deliveries for the entire time series are shown in *Table 2.1*.

The emission factors used for calculating greenhouse gas emissions resulting from military aviation and water-borne navigation are presented in *Table 2.2A and 2.2B*. The CO₂ emission factors are derived from the Ministry of Defence, whereas the emission factors for N₂O and CH₄ are derived from Hulskotte (2004).

2.2.7 Bunker fuels

The deliveries of bunker fuels for international aviation and water-borne navigation are derived from the Energy Balance. CO₂ emissions from bunker fuels are calculated using a Tier 1 and Tier 2 approach. Default heating values and CO₂ emission factors are used for heavy fuel oil and jet kerosene, whereas country-specific heating values and CO₂ emission factors are used for diesel oil, as shown in *Table 2.2* and described in Netherlands' list of fuels (Zijlema 2017). CH₄ and N₂O emissions resulting from the use of bunker fuels are calculated using a Tier 1 approach, using default emissions factors for both substances.

2.3 Uncertainties and time series consistency

The uncertainty estimates for the activity data and emission factors used for the different source categories described above are shown in *Table 2.6*. The sources for the uncertainty estimates are also shown in *Table 2.6*. The uncertainty estimates for the activity data are for the most part derived from the experts from Statistics Netherlands who are responsible for compiling the Energy Balance. For most activity data the uncertainty is deemed rather small. Uncertainty in CO₂ emission factors is based on expert judgement, as described in more detail in the National Inventory Report. For CH₄ and N₂O emission factors, the uncertainty estimates for the most part are derived from the 2006 IPCC Guidelines.

In general, the uncertainty in CO₂ emission estimates is deemed rather small, whereas uncertainty in N₂O and CH₄ emission estimates is deemed large. It should be noted though that the share of N₂O and CH₄ in total greenhouse gas emissions from transport (in CO₂ equivalents) is very small.

3 Road Transport

3.1 Source category description

Road transport includes all motorized vehicles that are licensed and which travel on public roads. Road transport comprises, among other things, passenger cars, light-duty trucks, lorries, road tractors, buses, special purpose vehicles (such as fire trucks and refuse trucks) and powered two-wheelers such as motorcycles and mopeds.

With the exception of a relatively small number of electric vehicles, road vehicles are equipped with a combustion engine for propulsion. In such engines, the chemical energy of fuels such as petrol, diesel and LPG is converted into mechanical energy. During this conversion process, various substances are emitted via the exhaust gas. In addition, emissions are released by the evaporation of motor fuels and coolants, the wear of brakes, tyres and the road surface, and the leakage and consumption of motor oil. Depending on the emission process, a specific calculation method is used. This is described in more detail in Section 3.2.

The emissions of air pollutants by road transport are reported under source category 'Road Transport' (1A3b) in the NFR. This source category comprises all emissions from road transport in the Netherlands, including emissions from passenger cars (1A3bi), light-duty trucks (1A3bii), heavy-duty vehicles and buses (1A3biii) and mopeds and motorcycles (1A3biv). It also includes evaporative emissions from road vehicles (1A3bv) and PM emissions from tyre and brake wear (1A3bvi) and road abrasion (1A3bvii). PM emissions caused by resuspension of previously deposited material are not included in this source category.

The UNECE Guidelines for reporting air pollutant emissions under the LRTAP convention (UNECE 2014) prescribe that emissions from road vehicle transport should be consistent with the national energy balance and therefore should 'be calculated on the basis of the fuel sold in the Party concerned'. In order to derive air pollutant emissions on the basis of fuel sold in the Netherlands, emissions are first calculated 'bottom-up' using data on vehicle kilometres driven and specific emission factors per vehicle kilometre (i.e. on the basis of fuel used in the Netherlands). The resulting emissions on Dutch public roads are used annually for air quality modelling. For international reporting, the emissions are subsequently adjusted to correct for differences between fuel used and fuel sold in the Netherlands. This is described in detail below.

3.2 Emissions processes and calculation methods

Emissions from road transport originate from different processes, including combustion of motor fuels in the engines of road vehicles, evaporation of motor fuels, and wear of tyres and brakes. Different methodologies are used for these processes, as described below. This section only describes the methodologies used, the actual activity data and emission factors used in these methodologies are described in Section 3.3.

3.2.1 Technology dependant exhaust emissions

The exhaust emissions of carbon monoxide (CO), volatile organic compounds (VOC), nitrogen oxides (NO_x), ammonia (NH₃) and particulate matter (PM₁₀) that result from combustion of motor fuels in the engines of road vehicles depend on the type of fuel, the engine and exhaust gas after treatment technology as well as on driving behaviour. These emissions are calculated by multiplying the vehicle kilometres travelled on Dutch territory per vehicle type by emission factors per vehicle type, road type and congestion level, expressed in grams per vehicle kilometre. The emission factors are derived annually from measurement data under test conditions and from real-world driving.

Figure 3.1 shows the different steps for calculating the exhaust emissions of CO, VOC, NO_x, NH₃, and PM₁₀ from road transport. The calculation begins with determining the emission factors (grams per vehicle

kilometre) per vehicle class per road type. The vehicle classes are defined by the vehicle type (passenger cars, light-duty trucks, etc.), weight class, fuel type, emission legislation class (Euro standards) and, for specific vehicle types, the engine and exhaust gas technology used to comply with the specific Euro standard (e.g. the use of Exhaust Gas Recirculation (EGR) or Selective Reduction Catalysts (SCR) to comply with Euro V emissions standards for heavy-duty engines). *Table 3.1* shows the vehicle categories used according to type of fuel and weight class. *Table 3.2* shows the different environmental regulations (Euro standards) for light-duty and heavy-duty vehicles, including the specific dates when the legislation entered into force. *Table 3.37* shows the shares of different exhaust gas technologies applied for specific Euro classes. *Table 3.38* shows the shares of hybrid vehicles and CNG vehicles in vehicle sales per Euro class. With each new Euro standard, emission standards were tightened, resulting for the most part in lower real-world emissions per vehicle kilometre.

Figure 3.1 Calculating emissions from road transport, actual emissions of CO, VOC, NO_x, N₂O, NH₃, and PM₁₀ due to combustion of motor fuels

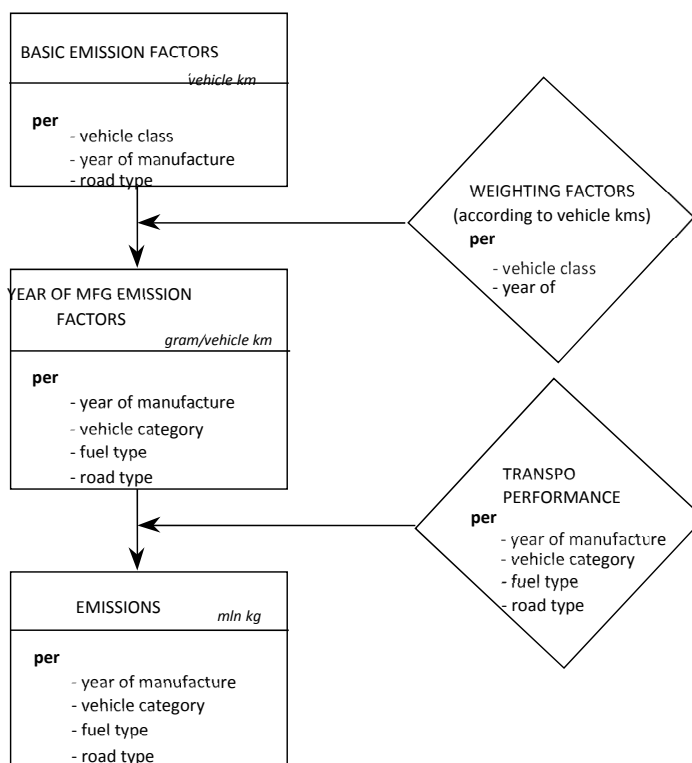

When determining the vehicle class specific emission factors, a distinction is made between three different road types. Road type refers to travelling within the urban area (RT1), on rural roads (the roads outside the urban area with a typical speed limit of 80 km/hour; RT2) and on motorways (RT3). The distinction between road types is necessary because emissions per vehicle kilometre can differ greatly not only as a result of differences in maximum speed, but also as a result of differences in driving dynamics (degree of acceleration, deceleration, constant driving and idling). In addition, cold starts, which are characterized by relatively high emissions, mostly take place in urban areas.

The annual vehicle kilometres travelled per vehicle type are derived from Statistics Netherlands, which uses odometer readings from the 'National Car Passport' to estimate average annual mileages per vehicle type. These annual mileages are derived per fuel type and per year of build. For these reasons, the detailed emission factors are aggregated into year-of-manufacturing emission factors. To this end, the emission factors per vehicle class are weighed with the share in sales of new vehicles during a specific year (*Tables 3.3 and 3.4*). An example of the result would be a year-of-manufacturing emission factor for an average

passenger car with a diesel engine manufactured in 1995 which travels within an urban area. *Tables 3.13 - 3.15* show the year-of-manufacturing emission factors for the statistical year 2014 for passenger cars, motorcycles and mopeds (3.13), light-duty trucks and special vehicles (3.14) and heavy-duty vehicles (3.15).

The year of manufacturing emission factors are then multiplied by the vehicle kilometres travelled (per year of manufacturing and per vehicle category – the lowest diamond in Figure 3.1 – to arrive at the emissions per vehicle category per road type. For the 1990-1997 period, the allocation of total vehicle kilometres travelled per vehicle type to the different road types is based on the figures from Statistics Netherlands about the use of roads. Recent allocation figures are based on a survey by Goudappel Coffeng (2010).

3.2.2 Fuel dependant exhaust emissions

Figure 3.2 shows the calculation method used for the exhaust emissions of SO₂ and heavy metals by road transport. The emissions of these substances are directly related to the fuel consumption of vehicles and to the type of fuel. The fuel consumption (the diamond in Figure 3.2) is derived by multiplying fuel consumption factors with the number of kilometres travelled by different types of vehicles in the Netherlands, as described in detail in the next section. The emission calculation involves multiplying emission factors (gram/litre of fuel) with the fuel consumption per vehicle category, fuel type and road type.

Figure 3.2 Calculating emissions from road transport, emissions of SO₂ and heavy metals (cadmium, copper, chrome, nickel, zinc, lead, vanadium) due to combustion of motor fuels

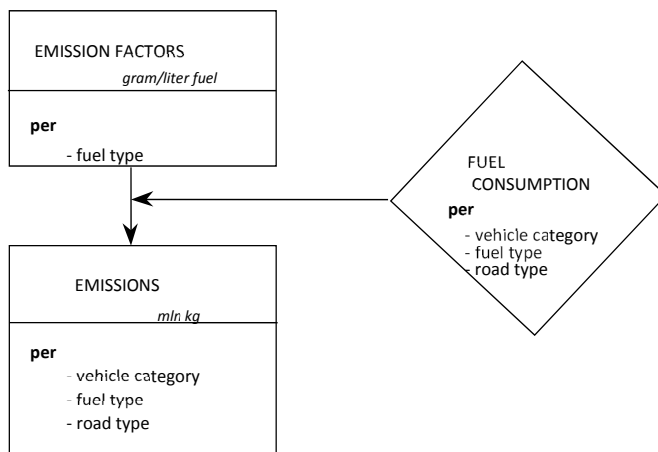

3.2.3 Exhaust emissions of VOC and PAH species

The calculation of the exhaust emissions of approximately 70 different VOC species, including methane and PAHs, takes place by using species profiles, as is shown in Figure 3.3. For each fuel type, so-called VOC species profiles are used (*Tables 3.27A-E*). In addition, for petrol-fuelled vehicles a distinction is made between those with and without a catalyst, because the catalyst oxidizes certain VOC components more effectively. The profile indicates the fractions of the various VOC components in the total VOC emission. By multiplying the total VOC emission with the fractions from a profile, the emissions of individual VOC components are estimated. The VOC and PAH profiles for each fuel type were obtained from a literature study (VROM 1993). For diesel powered vehicles from year of construction 2000 and later and petrol fuelled vehicles equipped with a 3-way catalytic converter, TNO has established new profiles (Ten Broeke & Hulskotte 2009). The new profiles are shown in *tables 3.27B and 3.27D*.

Figure 3.3 Calculating emissions from road transport, emissions of VOC and PAH components caused by combustion of motor fuels

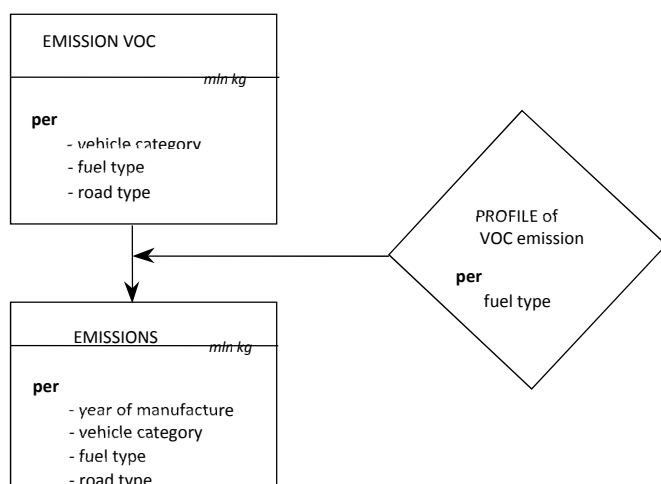

3.2.4 Evaporative emissions of VOC and VOC components

Petrol evaporates to some extent from vehicles when they are parked, when they cool off after travelling and while they are travelling. In the Netherlands the evaporative emissions are calculated according to the methodology described in the European 'Emission Inventory Guidebook 2007' (EEA 2007). This methodology distinguishes three mechanisms which are primarily responsible for the evaporative emissions from petrol driven vehicles (in case of LPG, diurnal emissions only):

1. Diurnal emissions

Diurnal emissions are evaporative emissions caused by the daily variation in the outdoor temperature. A rise in temperature will cause an increase of the amount of petrol vapour in the fuel system (tank, fuel pipes and fuel injection system). Part of this vapour is emitted (together with air) from the system to prevent overpressure (tank breathing). Diurnal emissions mainly originate from the fuel tank and are not dependent on vehicle use. The amount of diurnal emissions is expressed in grams per vehicle per day.

2. Running losses

The running losses are evaporative emissions which occur while driving. The heat of the engine leads to the fuel heating up in the fuel system and thereby to evaporation of part of the fuel. In modern cars the usage rate of the car has no influence on the fuel temperature in the tank. Due to this the running losses (and also hot and warm soak emissions) of these cars are very low. Running losses are expressed in grams per car kilometre.

3. Hot and warm soak emissions

Hot and warm soak evaporative emissions are also caused by the engine heat and occur when a warmed up engine is turned off. The difference between hot soak and warm soak emissions is related to the engine temperature: hot soak occurs when the engine is completely warmed up. The evaporation of petrol is smaller when the engine is not yet entirely warmed up. Hot and warm soak emissions are expressed in grams per vehicle per stop.

The amount of petrol vapour released from these three mechanisms strongly depends on (variation in) outdoor temperatures, the fuel volatility and the type of fuel injection. Furthermore, running losses depend on vehicle use. Due to the application of carbon cannisters in new cars since the early nineties the

evaporative emissions of road transport have been reduced strongly. These cannisters adsorb the majority of the emitted petrol vapour, which is consequently led back into the engine.

The Emission Inventory Guidebook includes a generic set of emission factors for each of the mechanisms mentioned above. Within these sets a distinction is made into the cannister type, cylinder capacity, and average outdoor temperatures. Each set contains separate emission factors for cars with a carburettor and cars with fuel injection. Based on these factors a set of basic emission factors has been developed for the Dutch situation (see *Table 3.18*). For this purpose data on the composition and car kilometres of the Dutch vehicle fleet have been used. It is assumed that the introduction of cannisters and fuel injection took place simultaneously with the introduction of three-way catalytic converters. The average outdoor temperatures in the Netherlands have been determined on the basis of data from the Dutch Meteorological Institute (KNMI) on the average temperatures during 1990-2006. The basic emission factors have been converted into emission factors per vehicle per day for the Dutch situation (see *Table 3.19*). Finally it is assumed that 90% of the emissions take place in urban areas. Figure 3.4 shows the emission calculation process for evaporative emissions. The evaporative emissions of motor cycles and mopeds likewise based on emission factors from the Emission Inventory Guidebook 2007.

Petrol vapour released during tanking is attributed to the fuel circuit (filling stations) and not to vehicle use. Due to the low volatility of diesel fuel the evaporative emissions of diesel powered vehicles have been assumed negligible.

Figure 3.4 Calculating emissions from road transport, emissions of volatile organic substances (VOC) and VOC components caused by evaporation of motor fuels

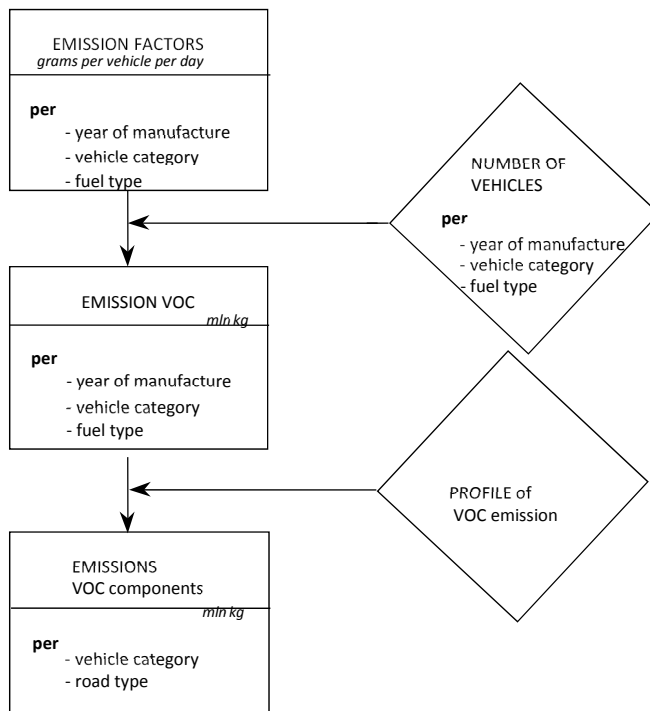

3.2.5 PM emissions resulting from wear of tyres, brakes and road surfaces

Wear of tyres, brakes and road surfaces result in particle emissions, some of which is PM₁₀ and PM_{2.5}. Figure 3.5 gives an overview of the calculation methodology for wear emissions.

Figure 3.5 Calculating emissions from road transport, emissions of particulate matter (PM₁₀) caused by wear of tyres, brake linings and road surfaces

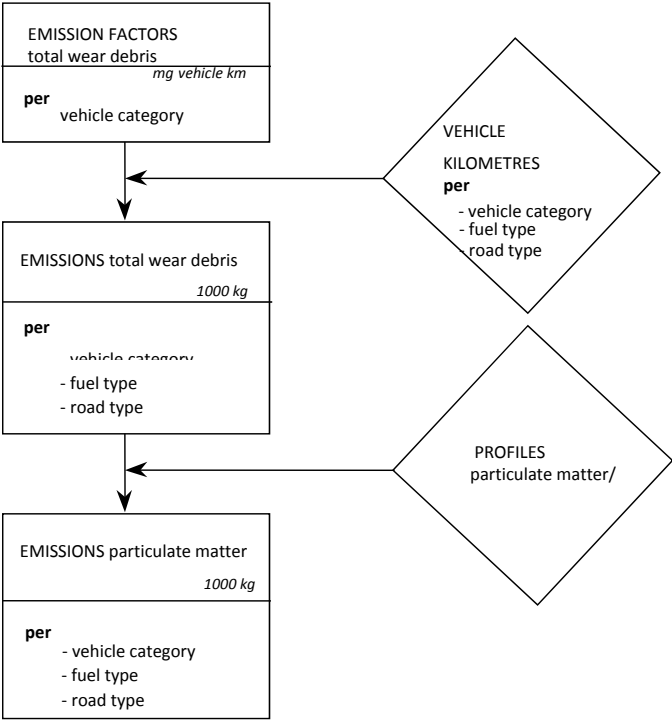

Tyre wear of road vehicles

Vehicle tyres experience wear due to the friction between the tyres and the road. This results in emissions of particulate matter (PM). The PM-emissions resulting from tyre wear are calculated by multiplying vehicle kilometres travelled with emission factors (milligrams of tyre particulate matter emission per kilometre). The emission factors are calculated as the total mass loss of tyres resulting from the wear process and the number of tyres per vehicle category. The emission factors used are shown in *Table 3.20A* and are derived from Ten Broeke et al. (2008).

The only macro-component that is emitted in large quantities is particulate matter (PM₁₀). It is assumed that 5% of the tyre particulate matter emission can be considered to be PM₁₀, the rest is larger fragments that do not stay airborne but are emitted to the soil or surface water. This share of 5% of particulate matter in the total mass of tyre particulate matter emission is an uncertain factor in the calculation of particulate matter emissions caused by tyre wear. The share of PM_{2,5} in PM₁₀ is estimated to be 20% (see *Table 3.35*).

The emissions of heavy metals caused by tyre wear are calculated by applying a profile of the composition of the total tyre material. This composition is shown in *Table 3.23B*. The heavy metals trapped in particulate matter are emitted to the air because it is assumed that 100% of particulate matter remains airborne. Heavy metals trapped in coarse particles fall back to the soil or the surface water. Within urban areas, it is assumed that 60% of coarse particles end up in water (*Table 3.20B*) which in this case means in the sewers, while 40% ends up in the soil. Outside urban areas, 10% emission to surface water is assumed in the calculations, and 90% to the soil. The emission factors for tyre wear are derived from Ten Broeke et al. 2008).

Wear of brake linings of road vehicles

Similar to the wear of tyres, the vehicle kilometres travelled and emission factors per travelled kilometre determine the emissions caused by the wear of brake linings. The emission factors are shown in *Table 3.20A*. The emission factors are derived from RWS (2008). It is assumed that the material emitted from brake linings is 49% particulate matter (PM₁₀) and 20% larger fragments. The remainder of the material (31%) remains on the vehicle. The share of PM_{2,5} in PM₁₀ is estimated at 15% (see *Table 3.35*).

The emissions of heavy metals caused by the wear of brake linings are calculated by applying a profile of the composition of brake lining material. The composition profile is shown in *Table 3.23B*. This table is derived from RWS (2008). For the allocation of the emissions of heavy metals to soil and water as a result of brake lining wear, the same percentages are used as with tyre wear emissions (*3.23B*).

Wear of road surface caused by road vehicles

The emissions of road particulate matter are calculated in the same manner as the emissions of tyre and brake lining particulate matter. It is assumed that the emission of road surface particulate matter is 1.6 times as large as that of tyre particulate matter emission. This factor is assumed to be independent of the statistical year. The emission factors are shown in *Table 3.20A* and are derived from Denier van der Gon et al. (2008). In the same manner as with tyre wear, it is assumed that 5% of the road particulate matter emission comprises particulate matter (PM₁₀) and that the remainder therefore comprises larger fragments. The share of PM_{2,5} in PM₁₀ is estimated 15% (see *Table 3.35*). The emissions of heavy metals from road surface wear were calculated in the past by using a profile of the composition of such fragments. Denier van der Gon et al. (2008) showed that hardly any heavy metals are released from road surfaces, so calculations of heavy metals are no longer carried out.

Denier van der Gon et al. (2008) also introduced new PAH emission factors. This study shows that in 1990 85% of the binders used in rural road and motorway surfaces were tar-based (TAG). After 1991 TAG is no longer applied and replaced by asphalt with bituminous binding agents. Because of this the PAH-content of road surfaces is lowered by a factor of 1,000 to 10,000. The PAH-emissions from road surfaces constructed after 1990 are therefore negligible. PAH emissions only occur from driving on roads with a surface from before 1991. Due to the gradual replacement of asphalt the old TAG is disappearing. It is estimated that in 2000 24% of the motorways and 51% of the rural roads contain TAG-asphalt. In 2004 this is reduced to 0% of the motorways and 27% of the rural roads. On roads in urban areas a major part of the road network consists of non-asphalt roads. It is assumed that by now all asphalt applied before 1991 on roads in built-up areas, has been replaced.

Effects of open graded asphalt mixes

On motorways on which open graded asphalt mixes¹ are used, the coarse particles that are deposited onto the road surface are partially trapped and are not washed to the soil or surface water. Because open graded asphalt mixes are periodically cleaned (approximately twice per year), these "trapped" coarse particles (containing heavy metals) are removed from the environment. Based on a memorandum from Centre for Water Management (Van den Roovaart, 2000) it can be determined that the emission of heavy metals to the soil and the water for open graded asphalt mixes is between 11 and 40 times lower than for closed graded asphalt mixes. For PAHs, this is a factor of 2.5. In the meantime, a large percentage of the motorways have been provided with a top layer of open graded asphalt mixes. *Table 3.25(B)* shows this percentage. The table also shows the factors for heavy metals and PAHs with which the total quantities of heavy metals and PAHs that are deposited on open graded asphalt mixes must be multiplied to calculate the heavy metals and PAHs that are washed off the road surface. The table shows that in 2012, due to the application of open

¹ known as "ZOAB" in the Netherlands

graded asphalt mixes, the emission of heavy metals to the soil and surface water near motorways is approximately 56% lower than the case would be without this application.

Allocation to soil and surface water

The allocation of the coarse particle emissions to water and soil is different for the urban area, rural roads and motorways, because the washing down characteristics for these road types differ. When the coarse particles are deposited within urban areas, a percentage is washed away via the sewage system into the surface water, and this material is therefore indirectly considered to be emission to surface water.

The emission factors of tyre wear, brake lining wear and road surface wear, expressed in mg per vehicle kilometre, are shown in *Table 3.20A*. The profiles with respect to the allocation to water and soil (and air) are shown in *Table 3.20B*.

Figure 3.6 Calculation of emissions from road transport, emissions of PAH components and heavy metals (cadmium, copper, chrome, nickel, selenium, zinc, arsenic, vanadium) caused by wear of tyres, brake linings and road surfaces

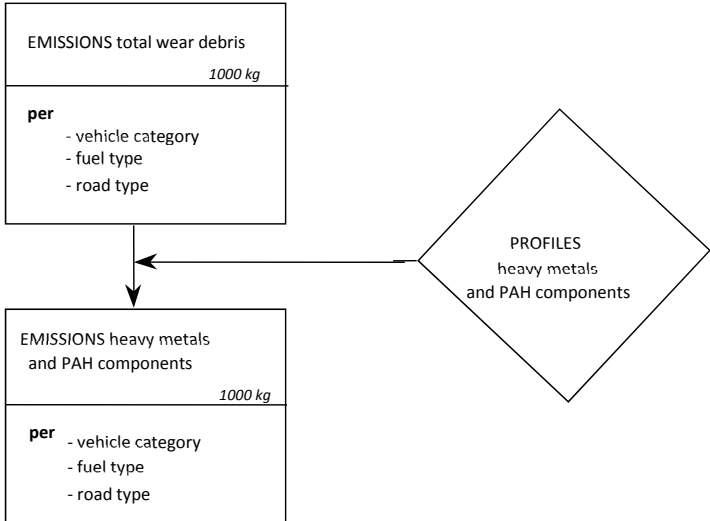

3.2.6 Leakage of lubricant oil; heavy metals and PAHs

The average oil leakage per vehicle kilometre travelled has been calculated in the past, derived from the total oil leakage in that year and the total number of vehicle kilometres. This calculation is based on measurements on roads that were interpreted by Feenstra and Van der Most (Feenstra & Van der Most 1985) and resulted in an average leakage loss of 10 mg per vehicle kilometre. The leakage losses for the various vehicle categories in road transport are calculated based on a set of factors, of which an example is given in *Table 3.21*. These factors are based on a number of assumptions that are listed in *Table 3.22*. One of the assumptions is that older vehicles have more leakage than younger vehicles (see also Figure 3.7).

The emission of heavy metals due to the leakage of lubricant oil depends on the composition of the oil. The heavy metal fractions in lubricant oil are shown in *Table 3.26B*. The calculation of the emission of PAH components due to oil leakage takes place in the same way as the calculation of heavy metals. *Table 3.26B* shows the composition used in the calculations (fractions of PAH components in lubricant oil).

Figure 3.7 Calculation of emissions from road transport, emissions of heavy metals (cadmium, copper, chrome, nickel, zinc, arsenic, lead) and PAHs due to leakage of lubricant oil from vehicles

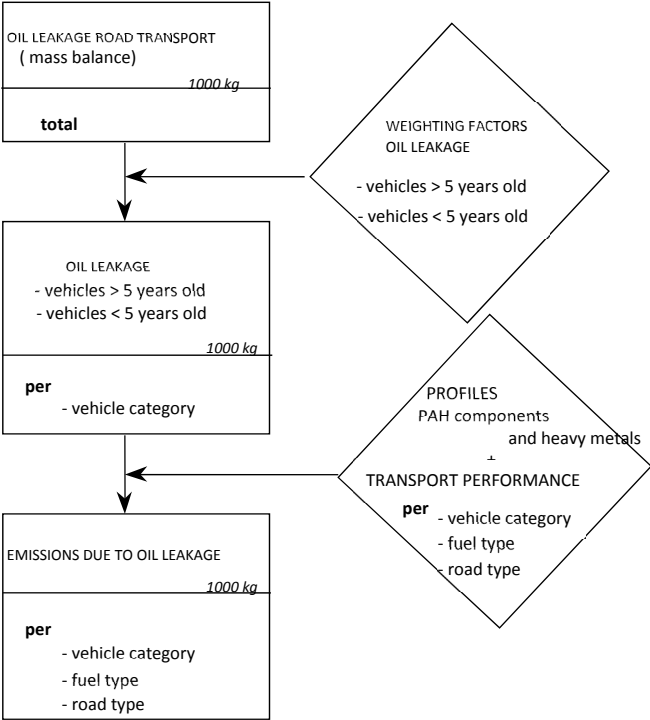

3.2.7 Consumption of lubricant oil; heavy metals

Oil consumption can be estimated with the vehicle kilometres and consumption factors for lubricant oil (Figure 3.8). It is assumed that the oil consumption of motor vehicles is 0.2 litre per 1000 km. For motorcycles and mopeds the consumption is assumed to be 0.1 and 0.67 litre per 1000 km respectively. Lubricant oil leaks via the piston rings into the combustion chamber of the engine, where it is burnt. Because this concerns a combustion emission, it is assumed that the emissions of other substances have already been registered via the exhaust gas emissions. The heavy metals are an exception. These are considered to be extra emissions and therefore are calculated separately by multiplying the consumption of lubricant oil and the lubricant oil profile (see Table 3.26B).

Figure 3.8 Calculation of emissions from road transport, emissions of heavy metals (cadmium, copper, chrome, nickel, zinc, arsenic, lead) due to consumption (combustion) of lubricant oil

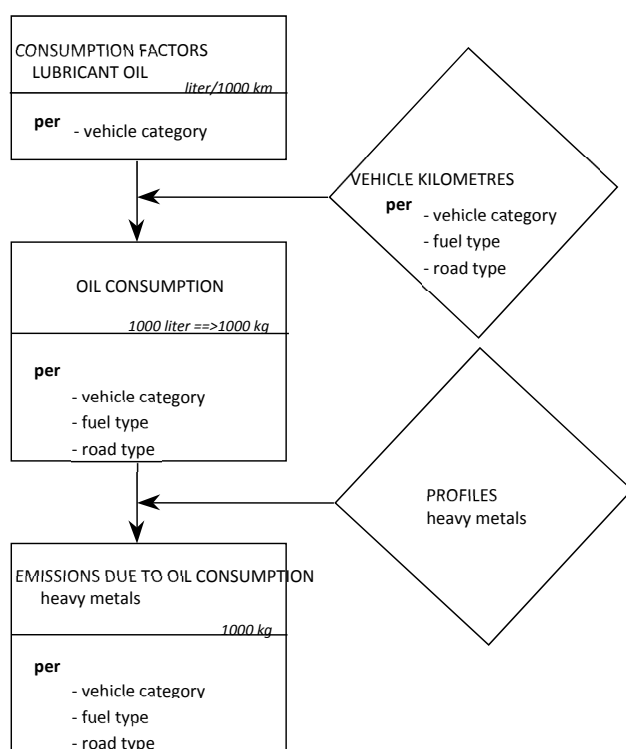

3.2.8 Fuel sold emissions from road transport

Historically, the emissions of NO_x, PM, NMVOC, CO and NH₃ from road transport in the Netherlands have been calculated and reported based on the number of vehicle kilometres driven per vehicle type. The resulting emission totals are referred to as *fuel used* (FU) emissions, since they correspond to the amount of fuel used by road transport on Dutch territory. The UNECE guidelines on reporting emission data under the LRTAP convention state that emissions from transport should be consistent with national energy balances as reported to Eurostat and the International Energy Agency (IEA). As such, emissions from road transport should be estimated based on *fuel sold* (FS) to road transport on national territory. In addition, emissions from road transport may also be reported based on fuel used or kilometres driven on national territory (UNECE 2014).

To derive fuel sold (FS) emissions from road transport, the fuel used (FU) emissions per fuel type are adjusted for differences between (estimated) fuel used by road transport in the Netherlands and fuel sold as reported by Statistics Netherlands. The methodologies used to estimate fuel consumption by road transport in the Netherlands are described in Section 3.4.2. Fuel sales to road transport are reported in the national Energy Balance and are adjusted for use of fuel in different applications, as described in Section 2.2.2 and shown in *Table 2.1*. Dividing fuel used emission totals per vehicle category by the total amount of fuel sold results in average emission factors per unit of fuel (kg/MJ). The resulting emission factors are given in *Table 3.39*. These emission factors are consequently combined with the fuel sales data from the Energy Balance, as shown in *Table 3.39*, to calculate total CH₄ and N₂O emissions from road transport.

3.3 Activity data for road transport

Data on the number of vehicle kilometres travelled in the Netherlands by different vehicle types are derived annually from Statistics Netherlands. Statistics Netherlands calculates total vehicle mileages using data on:

1. The size and composition of the Dutch vehicle fleet;

2. Average annual mileages for different vehicle types, and
3. The kilometres driven by foreign vehicles in the Netherlands.

Data on the size and composition of the Dutch vehicle fleet (1) are derived from RDW, which has information on all vehicles registered in the Netherlands, including vehicle characteristics such as weight, fuel type and year of manufacturing, and retrofitted installations. For each vehicle category, Statistics Netherlands provides detailed data (see Statistics Netherlands, [StatLine](#) and the [survey description](#) in Dutch). *Tables 3.5 (A and B) and 3.6* summarize this information for light-duty vehicles (less than 3.5 tonnes gross vehicle weight) and heavy-duty vehicles respectively. The data on the vehicle fleet does not include information on the number of vehicles with retrofit diesel particulate filters. These numbers are therefore estimated based on the number of vehicles that were retrofitted per year of manufacturing, as shown in *Table 3.34*. The resulting shares are shown in *Table 3.37*.

The annual mileages for different types of vehicles (2) are calculated by Statistics Netherlands from odometer readings from the national car passport corporation (NAP). The NAP database contains odometer readings from all road vehicles that have been to a car maintenance shop for maintenance or periodic inspection. Every year, Statistics Netherlands acquires a sample of the NAP database and uses this data combined with RDW-data on vehicle characteristics to derive average annual mileages for different vehicles types. This methodology is applied to derive average annual mileages for passenger cars, light-duty and heavy-duty trucks and buses. The resulting mileages are subsequently corrected for the amount of kilometres driven abroad. Average annual mileages for motorcycles and mopeds were derived by Statistics Netherlands in 2013 using a survey among owners, as is described in more detail in Molnár-in 't Veld et al. (2014). Brief descriptions (in Dutch) of the research by Statistics Netherlands (CBS) on the vehicle kilometres travelled of [passenger cars](#), [vans](#), [buses](#), [lorries/road tractors](#), and [special purpose vehicles](#) can be found on the CBS-website. More comprehensive methodological descriptions on how the vehicle kilometres are calculated are also available for:

- [Passenger cars](#) (Molnár-in 't Veld 2014);
- [Special purpose vehicles](#) (Kampert et al., 2014);
- [Buses](#) (Molnár-in 't Veld and Dohmen-Kampert, 2011);
- [Motorcycles and Mopeds](#) (Molnár-in 't Veld et al., 2014).

For earlier years of the time series, NAP register data were not yet available, therefore other data sources were used. The data for lorries and road tractors from 1990-1993 and buses from 1990-1997 have been derived from the so-called *BedrijfsVoertuigenEnquête* (Commercial vehicle survey), as described in CBSa (several volumes). The vehicle kilometre data for lorries and road tractors from 1994-2000 have been extrapolated by means of economic growth data for the transport sector.

The vehicle kilometres travelled in the Netherlands by foreign vehicles (3), as shown in *Table 3.28*, are estimated by Statistics Netherlands using several statistics. The vehicle kilometres travelled by foreign passenger cars are divided into kilometres travelled on trips including overnight stay (holidays, business trip) and kilometres travelled on trips without overnight stay (commuting, shopping, family visits, day trips). A survey on lodging accommodations ('*Statistiek Logiesaccomodaties*') during 1998-2013 has been used to estimate the number of kilometres travelled during trips with overnight stay. The estimation of kilometres travelled on trips without overnight stay is based on a German survey into transport intensity at 9 German-Dutch border-crossings, carried out in 1998, 2003, 2008 and annually from 2012 onwards. The years in between have been interpolated. The information available from the German-Dutch border-crossings was also used to estimate vehicle kilometres travelled for the years 1990-1997. Data are also derived from UK travel trends from 1999-2013 and *Reisonderzoek België* 2004-2012. The vehicle kilometres travelled by foreigners during 1990-1997 has been extrapolated with the use of data from the Dutch Mobility Survey (OVG) and the ratio between the kilometres driven by Dutch citizens and foreigners during 1998-2004.

The vehicle kilometres travelled by Dutch vans are based on the odometer readings database (NAP) in combination with the vehicle characteristics data from the Road Authorities (RDW). To divide the total of vehicle kilometres for Dutch vans by territory, data are used from the Goods Transport Survey, Eurostat, and the 1993 survey of Commercial Vehicles (Bedrijfsvoertuigenenquête). The use of vans is largely regional. The average trip distance is 32 kilometres. Vans are used by professionals like construction workers, tradesmen, technicians, catering staff, care staff and for parcel delivery etc. Unlike transporters that use lorries and road trans, drivers of vans do not make many large trips. However, if they cross the border it will often be limited to border transport. This applies not only to the use of Dutch vans but also to foreign vans. Unfortunately there are no data on kilometres travelled by foreign vans on Dutch territory. We therefore made the assumption that the vehicle kilometres travelled by Dutch vans outside the Netherlands, are more or less equal to those of foreign vans on Dutch territory. From the Goods Transport Surveys from 1997 to 2008 is derived that the kilometres of Dutch vans on foreign territory is on average 4 percent of the total kilometres driven. According to the assumption made, the total kilometres of foreign vehicles driven on Dutch territory has been equated with Dutch vehicle kilometres abroad. In 2012 the Goods Transport Survey (conducted by Statistics Netherlands) was expanded with additional questions about vans. From this study followed that of the total kilometres driven by Dutch vans in 2012 on average 4,1 percent is driven on foreign territory.

The vehicle kilometres travelled with foreign lorries and road tractors are derived from statistics concerning "goods transport on the roads²" as well as similar data based on Goods Transport Surveys from other EU countries as collected by Eurostat. The vehicle kilometres travelled with foreign buses are determined by using a model which is divided into 4 sections. The main sources per section are:

1. Transport by foreign coaches in the Netherland for stays of more than one day. The main source is a CBS tourism survey on accommodation (CBSb, several volumes) with data concerning the number of guests, overnight stays and destinations per country of origin. Travelled distances are calculated with a route planner.
2. Transport by foreign coaches in the Netherlands for day trips (so without overnight stays). The main sources are a CBS survey on daytrips and 'UK Travel Trends' (1998-2013).
3. Transport by foreign coaches through the Netherlands (drive through). For this purpose data have been used from 'UK Travel Trends' and the Belgian Travel Survey. In addition to this a route planner was used to calculate distances from border to border.
4. Transport by foreign buses in the Netherlands as part of regular bus services in the border regions. For this purpose information has been used from timetables (<http://www.grensbus.nl/>" and "<http://wiki.ovinnederland.nl>). Besides this Google Maps was used for a division of the bus lines into kilometres inland and abroad.

Also in case of the estimation of foreign coaches in the Netherlands several additional sources from different countries have been consulted, for instance:

- Report "Reiseanalyse Aktuell RA" (Forschungsgemeinschaft Urlaub und Reisen (FUR), 2002-2013): the percentage of holiday trips by Germans by bus, to the Netherlands, and to Western Europe, and the total number of holiday trips of 5 days and longer.
- Statistics on incoming Tourism: The percentage of foreign guests coming to the Netherlands by bus.
- The publication "Bustransport of passengers" (Eurostat/DG Tren, 1990-2000): for the number of passenger kilometres per bus or coach per EU country
- The publication "EU energy and transport in figures; statistical pocketbook 2013" (Eurostat /EC,1990-2011): traveller kilometres per bus or coach per EU country.

² Based on the Goods Transport Survey

- The publication "Statistisches Jahrbuch 2004" (Statistisches Bundesamt, 2004): total number of trips per bus to the Netherlands.
- "Reisonderzoek" (Algemene Directie Statistiek en Economische Informatie, 2000-2013) Belgium: total number of trips to the Netherlands by bus.
- "UK Travel Trends" (Office for National Statistics, 2000-2012): total number of trips to the Netherlands, totals and by bus
- "Movimientos turísticos de los españoles (FAMILITUR)" (Instituto de turismo de Espana, 1999-2013): percentage travels by bus.

The way the vehicle kilometres of foreign special purpose vehicles on Dutch territory are calculated is described in a methodological report on [Vehicle kilometres by special purpose vehicles](#) (Kampert et al. 2014).

The resulting activity data used in the emission calculations are shown in *Tables 3.7 to 3.11*. A major part of these data has been published in CBS Statline, namely the vehicle kilometres travelled by [passenger cars](#), [vans](#), [lorries](#), [road tractors](#), [buses](#) and [special purpose vehicles](#).

Allocation of vehicle kilometres to road category

For the emission calculations, a distinction is made between three road types: urban, rural and motorway. The road type distributions for different vehicle types are derived from Goudappel Coffeng (2010). In this study, a national transport model was used to estimate the distribution of total vehicle kilometres travelled on urban roads, rural roads and motorways, for passenger cars and light and heavy-duty trucks. Subsequently, data from number plate registrations alongside different road types throughout The Netherlands were used to differentiate these distributions according to fuel type and vehicle age. In general, it was concluded that the share of gasoline passenger cars on urban roads is higher than on motorways. Also, the fleet on motorways on average is younger than on urban roads. These differences can mainly be related to differences in average annual mileages: higher mileages in general result in higher shares of motorways in total mileages. For earlier years of the time series, the road type distribution is derived from the so-called 'Statistiek van de wegen' by Statistics Netherlands. The road type distribution of public transport buses and touring cars is derived from Den Boer et al. (2015).

Table 3.12 shows the allocation of total vehicle kilometres travelled in the Netherlands according to road type for the different types of road vehicles.

Share of vehicle classes in the vehicle kilometres per vehicle category

The emission factors for road transport are frequently differentiated per vehicle category according to various weight classes and vehicle classes. These detailed emission factors are aggregated into year-of-manufacturing emission factors based on the share of the weight classes and vehicle classes in the sales of new vehicles during a specific year. It is assumed that the number of kilometres per year is independent of the vehicle class. The weighting according to weight class is based on the database of the National Car Passport Autopas (NAP) and BVE (CBSa, multiple years). *Tables 3.3 and 3.4* contain weighting factors to aggregate the basic emission factors to year of manufacturing factors.

3.4 (Implied) Emission Factors for road transport

3.4.1 VERSIT+ emission factors for air pollutants

The detailed emission factors per vehicle class and road type for NO_x, PM₁₀, PM_{2.5}, VOC (HC), NH₃ and CO are derived annually from TNO. TNO uses the VERSIT+ emission factor model to calculate these emission factors. The following formula is used to determine the emission factors per vehicle class and road type:

$$\text{Emission factor} = \text{BASw} + \text{BASw} * (\text{AGEw}-1) + \text{PERCc} * \text{BASc} * \text{AGEc}$$

Where:

- **BASw** Emissions per vehicle kilometre travelled for a hot engine, excluding the effect of ageing;
- **AGEw** The effect of ageing on “hot driving”, depending on the year of use;
- **PERCc** Average number of cold starts per kilometre travelled
- **BASc** total extra emissions caused by driving with a cold engine
- **AGEc** the effect of ageing on the extra emissions caused by “cold start”, depending on the year of use

The resulting emission factors per vehicle class and per road type for CO, VOC, NO_x and PM₁₀ are shown in *Tables 3.29 through 3.32*. Below a brief description is given of the backgrounds for ascertaining the parameters in the formula above. Separate emission factors exist for retrofitted vehicles (Van Asch et al. 2009).

In-use compliance programme and dedicated measuring programmes

Since 1987, the basis for the emission factors of EU- regulated components (CO, VOC, NO_x and PM₁₀) has been the annual in-use compliance programme of TNO. As part of this programme, every year passenger cars and light and heavy-duty trucks (including many common makes and models) are tested under laboratory circumstances. In addition, supplementary (real-world) measurements are conducted on the vehicles. The selection process is designed to provide a good reflection of the total fleet of vehicles on Dutch roads over the years. In this selection process, the programme takes account of vehicle sales, type of fuels, vehicle class (Euro1, Euro2, etc.) and year of manufacturing. The vehicles were, in the past, obtained by writing to the users of the selected vehicle types and asking whether or not they would be willing to submit their vehicle for a test. The response to this request is relatively low, about 25%, and has been relatively constant in recent years. As part of the final choice of the vehicles to be tested, an important criterion is that there is sufficient spread in mileages and regular maintenance. In addition, both privately owned and leased vehicles are tested. In this way, the tested vehicles reflect the average usage and maintenance condition of the total fleet of vehicles in the Netherlands. Nowadays, vehicles are often provided by rental companies and commercial parties.

When they are submitted for testing, the vehicles are subjected to an NEDC type approval test, after which the measurement values are compared with the type approval values for the relevant vehicle and with the applicable emission standards. The vehicles that did not pass the test were repaired (if possible) and measured again. In recent years there has been a sharp decline in the number of cars that do not comply to the relevant emission standards. On average petrol fuelled cars always comply, for diesel cars this is the case to a lesser degree (Kadijk et al. 2015; Ligterink et al. 2012; Ligterink et al. 2013).

For the purpose of calculating the emissions from passenger cars TNO uses the measured emission factors before any maintenance is conducted. As a result, poorly tuned and/or poorly maintained vehicles are also included in the emission calculation. In order to prevent underestimation of real-world emissions, during the course of time the emphasis of the in-use compliance programme has moved more and more towards mapping of real-world emission performances instead of the execution of European NEDC type approval test cycles on new vehicles.

Hot engine basic emission factors (BASw)

Since 2005, TNO uses the VERSIT+ Transport emission model to calculate the basic emission factors from the emission measurements database. With the use of VERSIT+, emission factors can be calculated for different transport situations and scale levels. The emission factors follow from various analysis fed by different kinds of measuring data.

VERSIT+ LD (light-duty) has been developed for light-duty vehicles, i.e. passenger cars and light-duty trucks. The model can be used to estimate emissions under specific driving conditions (Ligterink & De Lange, 2009). For the determination of the emission factors (BASw) of light-duty vehicles, first the driving behaviour dependence and the statistical variation per vehicle has been investigated. Next the results have been used in a model with currently more than 50 light-duty vehicle categories for each of the 5 emission components. The resulting model separates optimal driving behaviour and vehicle category dependencies.

Pollutant emission levels from road vehicles are strongly influenced by driving circumstances. Representative real-world driving cycles are required to determine emission factors. The driving cycles for light-duty vehicles in the Netherlands have been updated in 2015 based on an extensive measurement programme (Ligterink, 2016). In total 108 hours of on-road driving were recorded, distributed over urban roads, rural roads and motorways with varying speed limits. The driving cycles that were previously used were determined in 2001. Since it is unknown how driving dynamics have evolved between 2001 and 2015, it was decided that the new driving cycles would only be used to determine emissions factors for Euro-5 and Euro-6 cars, being the dominant vehicle categories on the road in 2015. This means that the impact of the new driving cycles on the emission time series for passenger cars and light-duty trucks slowly phases in starting in 2009 when the first Euro-5 vehicles entered the vehicle fleet.

VERSIT+ HD (heavy-duty) (Riemersma & Smokers 2004) was used to predict the emission factors of heavy-duty vehicles (i.e. lorries, road tractors and buses). For older vehicles VERSIT+ HD uses input based on European measurement data. These data have been obtained with less realistic tests, meaning that in some cases only the engine has been tested and in other cases measurements have been executed with several constant engine loads and engine speeds (rpm). For newer vehicles (Euro-III – Euro-VI) measurement data are available with closer resemblance of the real world usage of the vehicles (Ligterink et al. 2009). These new data are based on realistic driving behaviour, both from on-road measurements and measurements on test stands, have been used in a model to represent emissions during standard driving behaviour. The emission factors for buses often originate from test stand measurements with realistic driving behaviour for regular service buses.

For the determination of the emission factors, the PHEM model was used which has been developed by the Graz University of Technology, using also measurement data from TNO. For pre-Euro-III the emission factors are still based on this model. Euro-III and later emission factors are based on TNO on-road measurements (Ligterink et al. 2012). The input is, just as for VERSIT+ LD, composed of speed-time diagrams which make the model suitable for the prediction of emissions in varying transport situations.

In the VERSIT+ HD the most important vehicle and usage characteristics for emissions are determined. For Euro-V the actual payload of a truck is important for the NO_x emission as the operation of the SCR relies on a sufficient high engine load. The payload of trucks were determined from on-road measurements on the motorway (Ligterink 2015). The usage characteristics of trailers are also collected from this data. Moreover, also PM emissions have a strong correlation with payload and the resulting engine load, which is taken into account in the emission factors.

Over the years, for most vehicle categories many measurement data have become available, which means that the reliability of VERSIT+ is relatively high. However, individual vehicles can have large deviations from the average (Kraan et al., 2014). TNO has even observed large variations of the measured emissions between two sequential measurements of the same vehicle. This is not the result of measurement errors, but of the great sensitivity of the engine management system, especially on petrol and LPG vehicles, to variations in how the test cycle is conducted on the dynamometer. Moreover, diesel emission control

systems also show a great sensitivity to variations in test circumstances. It has been paramount to ensure that the emissions correspond to the on-road results. VERSIT+ is used to predict emissions in specific driving situations, the commercial software EnViVer links the emission model to traffic simulations, but can also be used to predict emission factors on a higher level of aggregation, like in this case.

Cold start emissions (BASc and PERCc)

The cold start emission is seen as an absolute extra emission per cold start (expressed in grams per cold start). This emission is added for each road type to the emissions of the warm-up motor (and exhaust-gas after treatment). The measurements are performed by testing the vehicles on the dynamometer using a real-world driving cycles with both a cold engine as well as a warmed-up engine. The difference in emissions between the cold engine and the warmed-up engine for the whole cycle is the cold start emission. For spark-ignition engines the cold-start emission dominates the total emission on the test. For compression ignition engines the effects of cold start has only limited significance.

The average number of cold starts was estimated based on the OVG 1995 (CBS, 1996). According to the OVG, the average trip length in the Netherlands is 14.5 kilometres and the number of starts (cold plus warm) per travelled kilometre is therefore approximately 0.07. After this, an estimation was made for each personal trip motive concerning the number of cold starts in the total number of starts. For the personal trip motives commuting, visiting/stays, education and touring/hiking it can be stated with a large degree of certainty that virtually every start of the passenger car is with a cold motor/catalyst. For the other motives, the percentages are rather arbitrary.

On average, based on the assumptions about the percentage of cold starts per motive, it has been determined that approximately 60% of the starts are cold starts. The total number of cold starts per travelled kilometre is therefore 0.04. The allocation of cold starts inside and outside urban areas is based on the distribution of the number of households inside and outside urban areas, combined with differences in vehicle ownership per household between non-urban and urban areas. Based on this information, it was estimated that approximately 95% of all cold starts take place within urban areas, and the remainder takes place on rural roads.

In 1995, according to Statistics Netherlands, approximately 25% of the passenger vehicle kilometres took place within the urban area, and more than 35% on rural roads. This means that the number of cold starts per passenger car kilometre on urban roads is approximately 0.15 and for rural roads approximately 0.005. These values are used in the emission calculations for all categories of passenger cars, despite the intuitive perception that the average trip length of small vehicles is less than large vehicles, and therefore the number of starts per kilometre is higher. This is counterbalanced by the fact that small vehicles are especially used for motives where relatively fewer starts take place with a cold engine.

Aging (AGEw and AGEc)

The effects of vehicle aging are determined using data from the in-use compliance programme of TNO. The sample includes multiple vehicles with different odometer readings of various vehicle types (for example a Volkswagen Golf or a Peugeot 205). By comparing the emissions at different odometer readings a trend in emission increase or decrease can be observed over the course of time. The running-in period of several thousand of kilometres is not taken into account.

A distinction is made between the effect of ageing on the emission factor with a warm engine and exhaust gas treatment techniques and the effect of ageing on the extra cold start emissions. In the case of a warm engine the change in emissions due to ageing is primarily determined by the fact that the conversion efficiency of the warm catalyst declines in the course of time and is also caused by ageing of technical aspects of the motor in the form of, for example, wear of piston rings and valves. In the case of a cold engine the change in emissions due to ageing is caused by the fact that it takes longer for the exhaust gas aftertreatment device to reach operational temperature (and its maximal conversion performance). The methodology is described in detail in Van Zyl et al. (2015a).

Air conditioner effects (ACCESSORIES and PERCac)

The percentage of new passenger cars that are equipped with air conditioners has increased rapidly in recent years. The RAI has calculated that this percentage was 45% in 1998 and in recent years a large majority of (new) cars is equipped with air conditioners. For the determination of the correction factors for the use of air conditioners, measurements performed by EMPA [Weilenmann, 2005] are used. EMPA has measured vehicles under different circumstances (regarding temperature and time in the sun). TNO has used these measurements to derive correction factors for the Dutch situation. The only EMPA measurements used are the measurements where the vehicle had to be kept at a certain temperature by the air conditioner.

The most important reason for the negative effects on emissions resulting from the use of air conditioners is that the engine management system is generally not adjusted to the use of an air conditioner because during the vehicle type approval test, the air conditioner can remain turned off. The use of an air conditioner affects the operation of the lambda control system, which causes the conversion efficiency of the catalyst to decrease. In addition, even without deterioration of the lambda control, the increase in the total energy being generated leads to increased emissions and fuel consumption.

For diesel vehicles, an air conditioner operating at full capacity sometimes leads to a decrease in emissions. The reason for this is that diesel engines emit more components resulting from incomplete combustion (CO and VOC) when the motor has a relatively low load than with a higher load. In some cases, the increased motor load that is linked with the use of the air conditioner therefore has a beneficial effect on the emissions. The effect on cold start emissions has not been assessed, but it is expected that there will be a neutral emission behaviour because a small increase in engine emissions (with a cold catalyst) will be compensated by a shorter warm-up time for the catalyst (due to the higher load on the motor). The fuel consumption, in contrast, will increase due to the increased load on the engine.

No data are known about the average use of vehicle air conditioners in the Netherlands. Research from France has shown that vehicle air conditioners are used on average 200 hours per year. TNO has calculated that the average passenger car is used for 570 hours per year. If it is assumed that air conditioners in vehicles in the Netherlands, due to the colder climate, are used for only 100 hours per year, and that the average driving speed does not differ between driving with the air conditioner on or off, then the percentage of kilometres that are travelled with the air conditioner on is approximately 18%.

With the shift to on-road emission testing for newer generations of vehicles, such correction factors are no longer applied. Effects of additional weight, wind, temperature, lights, etc. are included in the on-road test results. Therefore a correction of the emission factors for the use of air-conditioning is no longer necessary. Moreover, the efficiency of air-conditioning has improved significantly such that the results of the studies in the past can no longer be applied with confidence. Air-conditioning is now expected to affect the average fuel consumption by less than 2%.

3.4.2 Fuel consumption and fuel related emission factors

Until 2012 fuel consumption was derived from the vehicle kilometres travelled and specific fuel consumption (km/l) per vehicle type, as derived from surveys by Statistics Netherlands such as the PAP (Passenger Car Panel), the BVE (Commercial vehicles), and the motorcycle owners survey. These surveys have been discontinued. Therefore in 2013 and 2014 three projects were carried by Statistics Netherlands and TNO to calculate fuel consumption and CO₂ emissions from road transport. The basic data used for all three calculations are derived from the national vehicle register and the odometer readings. For passenger cars the CO₂ emissions as measured during the type approval of the car were combined with insights on the difference in CO₂ emissions between type approval and real-world operation. For the calculation of fuel consumption and CO₂ emissions of lorries and road tractors a new model was used including new knowledge with respect to the loading of these freight vehicles. The research projects are described in more detail in Staats et al. (2014), Willems et al. (2014) and Kruiskamp et al. (2015). See:

- [Bottom-up calculation of CO₂ by passenger cars \(report in Dutch\)](#)

- [Bottom-up calculation of CO2 by lorries and road tractors \(report in Dutch\)](#)
- [Bottom-up calculation of CO2 by delivery vans \(report in Dutch\)](#)

The results of the surveys can be found on the CBS website:

- [Fuel consumption and CO2 emissions of passenger cars in The Netherlands](#)
- [Fuel consumption and CO2 emissions of lorries and road tractors in The Netherlands](#)
- [Fuel consumption and CO2 emissions of delivery vans in The Netherlands](#)

Table 3.33A gives a summary of the results.

The specific fuel consumption of the other vehicle types are still based on the old method.

In order to directly allocate fuel-consumption-dependent emissions according to road type, ratio factors were determined using the VERSIT model (Lefranc, 1999), see also Section 3.4.1. With these ratio factors, the fuel consumption for the three road types can be derived from the average fuel consumption. See *Table 3.33B* for these ratio factors.

The emission factors for SO₂ and for heavy metals have been derived from the sulphur and heavy metal content of the motor fuels. *Table 3.24* shows the fuel quality data for various statistical years for calculating the emissions of SO₂ and lead. It is assumed that 75% of the lead leaves the exhaust as air-polluting particulates and that 95% of the sulphur is converted into SO₂. The amounts of heavy metals in motor fuels are shown in *Table 3.23A*. It is assumed that the content of heavy metals (except lead) is independent of the statistical year.

3.4.3 Other emission factors

Table 3.17 shows the emission factors for NH₃, which were derived from Stelwagen & Ligterink (2015a). EC emission factors were derived from Stelwagen & Ligterink (2015b). Emission factors for alternative drivelines and alternative fuels were derived from Ligterink et al. (2014). The emission factors for evaporative VOC emission are shown in *Table 3.18*. These factors have been converted into average factors per vehicle, per day (see *Table 3.19*). The emission factors were estimated using the methodology from the EEA Emission Inventory Guidebook, as described in Section 3.2.4.

Table 3.20A shows the emission factors used for wear of brake linings, tyres and road surface, whereas *Table 3.20B* shows the share of wear emissions that is assumed to be emitted to air, water and soil. The heavy metal composition of particulate matter emission due to wear is shown in *Table 3.23B*. The data in this table concerning brake wear originate from (RWS 2008).

Table 3.21 shows an example set of the emission factors for leakage losses and combustion of lubricant oil. The basic data for converting to emission factors according to the age of the vehicle are shown in *Table 3.22*. The heavy metal factors for lubricant oil in mg per kg of oil (leakage and consumption) are shown in *Table 3.23A*.

3.4.4 VOC species profiles

For the VOC species profiles that are used to break down VOC emissions into individual components, a distinction is made according to the type of fuel. For petrol vehicles, a distinction is also made according to those with and without a catalyst, because the catalyst oxidizes certain VOC components more effectively than others. The profile shows the fractions of the various VOC components (approximately 40) in total VOC emissions. The VOC profiles per type of fuel originate from literature studies (VROM, 1993 and Ten Broeke & Hulskotte 2009). They are shown in *Tables 3.27A* and *3.27B*. These literature studies are also used to derive PAH profiles, expressed in grams/kg of VOC emissions studies. *Tables 3.27C* and *3.27D* show these profiles per type of fuel, where – like the VOC profiles – a distinction is made between petrol used with and

without a catalyst and diesel fuelled vehicles from before and after 2000. In addition, petrol for two-stroke engines has a deviating profile

The VOC components in the evaporative emissions are also calculated with a VOC profile that was ascertained by TNO (see *Table 3.27A*). This profile is based on “Emissiefactoren vluchtige organische stoffen uit verbrandingsmotoren” (VROM 1993) but has been modified because the maximum benzene and aromatics content of petrol was reduced on 1 January 2000 due to EU legislation. The stricter requirements regarding benzene are shown in *Table 3A* below.

The reduction of the content of benzene and aromatics in petrol has direct consequences for the benzene and, to a lower extent, aromatics content in the evaporative emissions of these petrol-fuelled vehicles. The link between the benzene content in petrol and the benzene content in the exhaust gas, however, is complex: at low speeds, according to Heeb et al. (2002), the benzene content in the exhaust gas declines by 20-30% when the benzene content in the petrol declines from 2% to 1% per volume, while at high speeds at rich engine operation the benzene content in the exhaust gas actually increases. Because this relationship is too complex to model in the Emission Inventory, and because the decline of the benzene content in exhaust gas is relatively small on balance, the transport task group decided to leave the benzene content in the exhaust gas unchanged. Moreover, such effects are observed with older technology, and likely not to be so for Euro-5 and Euro-6 petrol vehicles. However, the benzene content in petrol and in petrol vapour has been modified. In addition, the toluene content in petrol and petrol vapour has been corrected with retroactive effect for historical years.

Table 3A Several emission-relevant requirements for motor petrol according to EN228

Parameter	1999	2000
Benzene content, vol. % (maximum)	5	1
Aromatics content, vol.% (maximum)	-	42
Vapour pressure summer kPa (maximum)	80	60
Sulphur content, mg/kg (maximum)	500	150

Although there is no information on structural research regarding the enforcement of these internationally-applicable agreements, based on the best available information it is assumed that structural violation of these requirements concerning motor petrol does not occur in the Netherlands. In Belgium, it appeared that the petrol indeed contained less than 1% of benzene by volume in 2000, while in 1999, this was still more than 1% by volume (FAPETRO 1999 & 2000). A number of the emission profiles linked to petrol or petrol vapour that are applied in the Emission Inventory have therefore been modified. Based on the available information (EU, 2002 & FAPETRO 1999 & 2000; Machrafi & Mertens, 1999; Shell, 2000), it was decided to use two emission profiles for benzene and benzene vapour, one before 1999 and one after. Because the benzene content had not yet been changed in the Netherlands in 1999 (Machrafi and Mertens 1999) it was decided to implement the changes based on analyses in Belgium (FAPETRO 2000) in the expectation of the research in the Netherlands, which hopefully will be conducted in the near future. According to European legislation, every Member State must report on fuel quality during the previous year on June the 30th of every year. The Dutch monitoring results are published on the [EU-website](#). *Table 3B* below shows the emission profiles for the statistical year 1999 and before, and for the statistical year 2000 and afterwards.

Table 3B Emission profile for the emission of benzene (percentage by weight)

	Petrol	Petrol vapour
--	--------	---------------

	1999 before	2000 and and later	1999 before	and 2000 and and later
Benzene ¹⁾	2.5	0.8	1	0.3
Toluene	15	12.5	3	2.5
Xylene	-	-	0.5	0.5
Aliphatic hydrocarbons (non-halogenated)	35	60	95	97
Aromatic hydrocarbons (non-halogenated)	65	40	5	3

¹⁾ A factor of 1.2 was used to convert the volume percentage of benzene to the weight percentage.

3.4.5 Emission factors for motorcycles and mopeds

VERSIT+ does not include emission factors for motorcycles and mopeds. Emissions from motorcycles and mopeds are derived using an emission model that was developed by TNO (Dröge et al. 2011 & Van Zyl et al. 2015b). The results have been used in the emission calculations. *Table 3.36* shows the average annual emission factors (CO, VOC, NO_x and PM₁₀) for motorcycles and mopeds for the time series.

3.5 Uncertainties

This section provides an explanation of estimates of the uncertainties in the emissions as shown in the Appendix.

3.5.1 Uncertainties in activity data

The number of vehicles that is used, among other things, for calculating oil leakage and evaporative emissions originates from the RDW Centre for Vehicle Technology and Information. The RDW registers all motor vehicles in the Netherlands; consequently, the number of vehicles is based on extremely precise measurements (A).

Until 2006 the vehicle kilometres travelled by passenger cars were measured by the PAP (Passengercar panel). At present, this information originates from the OVG/MON in combination with the database of the NAP (National Car Passport). This concerns reasonably accurate measurements (A), but with uncertainties due to the under-representation of "frequent drivers" (such as lease drivers) in the sample. During the transition from the PAP to the OVG, most of this uncertainty has probably been eliminated. On the other hand other uncertainties have been introduced, due to the type of survey which is not primarily intended to determine car kilometres.

The number of vehicle kilometres travelled by lorries, road tractors and buses has been based on data from the NAP (National Car Passport) from 2001 onwards, and *BedrijfsvoertuigenEnquete* – BVE of 1993. The share of kilometres abroad in the total vehicle kilometres by Dutch vehicles has been determined on the basis of results of CBS-goods transport statistics. The kilometres travelled by foreign vehicles in the Netherlands have been derived from European transport surveys.

The number of vehicle kilometres travelled by light commercial vehicles (vans) has been based on NAP data and data from the BVE of 1993. The share of kilometres abroad in the total vehicle kilometres by Dutch vehicles has been estimated 4%. The kilometres travelled by foreign vehicles in the Netherlands has been equated with Dutch vehicle kilometres abroad.

The uncertainty in the whole range of results for commercial vehicles has been classified B. The data of light commercial vehicles and of heavy commercial vehicles after 2001 can be given an A-classification.

The vehicle kilometre data for special purpose vehicles have been based on the discontinued BVE and therefore due for revision.

The subdivision of the number of passenger car kilometres according to year of manufacture increases the uncertainty. The subdivision according to road types (within urban areas, rural roads, motorways) also increases the uncertainty. Although the number of kilometres travelled on motorways is precisely measured, the number of kilometres travelled on rural roads is significantly less accurate. The number of kilometres travelled within urban areas is in fact a remainder of the above two road types and is therefore significantly more uncertain than the number of motorway kilometres.

Until 2000 the specific fuel consumption of road vehicles was measured in the PAP and the BVE. However, this did not concern actual measurements, but one-time estimates by the respondents. The uncertainty in these estimates is probably quite large. Nevertheless, this data is given the A classification due to the large sample size. After 2000 the specific consumption figures have been extrapolated based on expert judgement.

The fuel consumption per road type is calculated from the average consumption by using model calculations for the variations in fuel consumption between travelling on various road types, and is therefore more uncertain than the average consumption. The fuel consumption by road vehicles concerns calculated figures (resulting from specific fuel consumption and vehicle kilometres) and is more uncertain than both elements separately. Fuel sales to road transport are determined based on a survey among fuel suppliers (oil companies) and is relatively accurate (A).

3.5.2 Uncertainties in emission factors

Regarding the uncertainty in the emission factors of road vehicles, a distinction can be made according to 1) fuel-related emission factors, 2) regulated combustion and emission factors 3) non-regulated combustion and emission factors, 4) evaporative emission factors and 5) wear emission factors.

Note to 1: Fuel-related emission factors are used when calculating CO₂, SO₂ and heavy metals. These emissions are calculated by multiplying the fuel consumption with fuel-related emission factors (grams/kg of fuel). Of these emission factors, CO₂ is the most certain because this depends only on the carbon content of the fuel, and this carbon content is relatively certain. SO₂ depends on the sulphur content, and since in recent years this has not been structurally measured, the sulphur content, especially of petrol, is very uncertain. Although the emission factors for heavy metals are based on a recent study, they are still uncertain because the content of heavy metals depends on the composition of the refined crude oil and the fuel additives. Both can vary strongly.

Note to 2: Regulated combustion and emission factors are used for CO, VOC, NO_x and in the case of diesel vehicles, for PM₁₀ as well. Road vehicles have been subjected to emission standards for more than a decade; consequently, a relatively large number of measurement results are available. One example is the annual in-use compliance programme of the TNO, during which several dozen of vehicles are measured per year. The reliability of these emission factors is increased since using VERSIT+, but uncertainties still exist regarding the correction factors for the cold start, ageing and the use of air conditioners for older vehicles.

Note to 3: Non-regulated combustion emission factors are used among other things for NO₂, N₂O and VOC components such as aromatics (including benzene) and PAHs. Because the profiles are from the mid-1980s and both the fuel composition and the engine technology have changed since then, the reliability of these profiles has declined sharply. In 2002 a large-scale measurement programme was conducted to update the VOC profiles. The N₂O emission factors of passenger cars have recently been ascertained as part of a comprehensive measurement study and are therefore relatively reliable (B).

Note to 4: Evaporative emission factors express the quantity of evaporated petrol per vehicle per day. This depends on the age of the vehicle, because new vehicles must comply to stricter demands for the maximum evaporative emissions than older vehicles. Moreover, the evaporative emission depends on vehicle usage, because many short trips lead to more evaporative emissions than fewer long trips. In addition, the outdoor temperature is important. The evaporative emissions of road vehicles are scarcely measured in the

Netherlands, and emission factors are therefore based on the emission standards and the measurement results in other European countries. Evaporative emissions depend strongly on large diurnal temperature fluctuations and on longer periods of standing still, when the canister is not purged frequent enough. These underlying dependencies are poorly known, but expected to be limited in the Dutch situation.

Note to 5: Wear emission factors are derived from a mass balance and assumptions about the content of particulate matter in the total wear mass. This assumption is very uncertain. The zinc content of tyres, which was modified by the transport task group, has been recently confirmed in research conducted by BLIC, a central organization of tyre manufacturers. Moreover, the material composition varies from one tyre type to the next. In particular the chemical composition of light-duty tyres is different from heavy-duty ones.

3.5.3 Uncertainties in the emissions

The uncertainties in emission estimates, as shown in Appendix C, are derived from the uncertainty in activity data and emission factors in accordance with the rule that the uncertainty of the product of two uncertain factors is equal to the largest uncertainty in one of the two factors, therefore:

- $A * A = A$
- $A * B = B$
- $B * A = B$
- $A * D = D$, etc.

Quantitative estimates of uncertainties in total emissions for road transport are not available. Kraan et al. (2014) used a jackknife approach, taking selections of the input data, to estimate the uncertainty in reported NO_x emission of Euro 4 diesel passenger cars. This resulted in a 95% confidence interval of +/- 100% in emissions if all aspects are added up. This result is not necessarily applicable to other generations of (diesel) passenger cars though due to improvements in the measurement and modelling approach to generate real-world (NO_x) emission factors. On the other hand the number of vehicles that have been tested has decreased over the years, which in itself results in higher uncertainty in the emission calculations.

3.6 Points for improvement

VERSIT+ is a statistical emission model based on emission measurements. For this reason with every model update it is preferred to use as much new measurement data as possible. Version 3 of the VERSIT+ model has been developed in 2008. With this the statistical method has been renewed to achieve a better relationship between the instantaneous emissions and the vehicle's speed and acceleration. The generic driving behaviour variables per trip have been replaced by instantaneous variables for any moment. With this optimal use is made of the different kinds of measurement data. More information about this subject can be found in a TNO report (Ligterink & de Lange 2009).

In recent years, the determination of emission factors relies more and more on on-road emission measurements, with poorly understood variations. The amount of data per car is set at a minimum of two hours, instead of the 45 minutes in the case of the older chassis dynamometer tests. However, currently it is examined how to make the VERSIT+ emission model more robust against (unexplained) variations in the input data. Another aspect that needs more attention herein is the intricacies of modern emission control technology, and the effect of exhaust gas temperature on its operation. This is subject of ongoing research. However, the aim is to collect sufficient data such that the current approach remains statistical significant despite the variations.

4 Railways

4.1 Source category description

This chapter describes the methods that have been used to determine the emissions of rail transport in the Netherlands. This includes both passenger transport and freight transport. Most railway transport in the Netherlands uses electricity, generated at stationary power plants. Emissions resulting from electricity generation for railways are not included in this source category. This source category covers only the exhaust emissions from diesel-powered rail transport in the Netherlands. Diesel is used mostly for freight transport, although there are still some diesel-powered passenger lines as well.

Besides exhaust emissions from diesel trains, this source category also includes emissions due to wear, which result from friction and spark erosion of the current collectors (pantographs) and the overhead contact lines. This results, among other things, in emissions of particulate matter, copper and lead from trains, trams and metros.

Emissions of air pollutants by railway transport in the Netherlands are reported in the NFR under source category 'Railways' (1A3c).

4.2 Activity data and (implied) emission factors

4.2.1 Exhaust emissions from railways

The emissions of air pollutants from railway transport in the Netherlands are calculated using a Tier 2 methodology. The exhaust emissions of rail transport are estimated by multiplying the fuel consumption by emission factors per kg of fuel. Diesel fuel consumption for railways is derived annually from the Energy Balance, which uses different sources to construct the time series, as shown in *Table 4.1*. For recent years, fuel consumption data are derived from VIVENS (Association for joint purchase of energy for railway companies). For earlier years of the time series, data on diesel fuel consumption by railways was derived from NS (Dutch Railways). *Table 4.1* shows the fuel consumption figures and the origin of the data for the entire time series.

The emission factors for railways were derived from the National Institute for Public Health and the Environment (RIVM/LAE, 1993) in consultation with the NS (see *Table 4.2*). $PM_{2,5}$ emissions are calculated from PM_{10} by using an emission profile. *Table 4.3* shows the assumed share of $PM_{2,5}$ in the PM_{10} emissions. For the calculation of the NH_3 emissions, default emission factors were derived from the EEA Emission Inventory Guidebook (Ntziachristos and Samaras, 2000).

The emissions factors for SO_2 and heavy metals are derived from the sulphur and heavy metal content of the diesel fuel. *Table 3.24* shows the fuel quality data for various statistical years for calculating the emissions of SO_2 and lead. It is assumed that 75% of the lead leaves the exhaust as air-polluting particulates and that 95% of the sulphur is converted into SO_2 . The emissions of heavy metals are calculated by multiplying the fuel consumption with the emission factors that are based on the metal content of the fuels. The emission factors in grams per kilogramme of fuel are identical to the factors for diesel fuel for road transportation (*Table 3.23A*).

Emissions of different VOC and PAH species are derived from total VOC emissions using VOC and PAH species profiles ascertained by TNO Built Environment and Geosciences; these are equivalent to the diesel profiles for transport on the inland waterways (*Tables 5.7 A, B and C*) (VROM 1993).

4.2.2 PM₁₀ and heavy metals due to wear of overhead contact lines and carbon brushes

The calculation of wear emissions is based on a study conducted by NSTO (currently AEA Technology) in 1992 concerning the wear of overhead contact lines and the carbon brushes of the current collectors on electric trains (CTO 1993). The total emission of copper in 1992 was estimated by the NSTO at 20.7 tonne, of which 3 tonne was attributed to carbon brushes.

In combination with the electricity consumption for that year provided by the Dutch railways (approx. 1200 million kWh) and the fact that overhead contact lines are comprised entirely of copper, and carbon brushes are comprised of 25% copper, the total quantity of wear particles originating from overhead contact lines and current collectors can be determined per kWh of electricity consumption (overhead contact lines: approx. 15 mg/kWh; carbon brushes: approx. 10 mg/kWh). For trams and metros, the wear of the overhead contact lines is assumed to be identical per kWh of electricity consumption. The wear of current collectors is not included, because no information is available on this topic. Carbon brushes, besides copper, contain 10% lead and 65% carbon.

Based on the NSTO study referred to above, the percentage of particulate matter in the total quantity of wear debris is estimated at 20%. Due to their low weight, these particles probably remain airborne. According to Coenen & Hulskotte (1998), approximately 65% of the wear debris ends up in the immediate vicinity of the railway, while 5% enters the ditches alongside the railway. According to the NSTO study, the remainder of the wear debris (10%) does not enter the environment, but attaches itself to the train surface and is captured in the train washing facilities.

4.3 Uncertainties

The uncertainties in emission estimates have been derived from the uncertainty in activity data and emission factors in accordance with the rule that the uncertainty of the product of two uncertain factors is equal to the largest uncertainty in one of the two factors, therefore:

- A * A = A
 - A * B = B
 - B * A = B
 - C * C = C
 - A * D = D
- etc.

The results are shown in the Appendix.

4.4 Points for improvement

The emission factors for railways are outdated and need to be updated, taking into account the different stages of the EU emission legislation for railway diesel engines.

5 Inland navigation

5.1 Source category description

This chapter describes the methods that have been used to calculate the emissions from inland navigation. Inland navigation is defined as all motorized vessels that travel on the inland waterways in the Netherlands. Transport on the inland waterways comprises, among other things, professional freight transport, passenger transport and recreational craft.

The propulsion that is used in inland navigation for freight and passenger transport in the Netherlands is provided by diesel engines. The combustion processes that take place in these diesel engines cause emissions of air pollutants. The most important substances emitted are carbon dioxide, nitrogen oxides, particulate matter (PM₁₀), carbon monoxide, hydrocarbons and sulphur dioxide. Carbon dioxide and sulphur dioxide are caused by the oxidation of the carbon and sulphur present in the fuel. The emissions of these substances therefore depend completely on the contents of carbon and sulphur in the fuel and quantity of fuel that is combusted. Nitrogen oxides are primarily caused by the high temperatures and pressures in the combustion engines, which causes the nitrogen present in the atmosphere to combine with oxygen. Carbon monoxide, hydrocarbons and particulates are products of incomplete combustion. The emissions of the latter substances therefore mainly depend on the technical properties of the engines and the way in which these engines are used.

The propulsion of recreational craft takes place using both petrol and diesel engines. With petrol engines, a distinction can be made between outboard engines (usually two stroke engines) and inboard engines (usually four stroke engines). Diesel engines are inboard engines. The most widely sold engines are small outboard engines. Petrol engines usually have an underwater exhaust, which results in a significant portion of the emitted substances dissolving in the water and therefore not entering the atmosphere. Diesel engines have an above-water exhaust. Nevertheless, diesel engines can also cause water pollution, especially when the cooling water from the motor is discharged through the exhaust.

Generally speaking, engines for recreational vessels are comparable with automobile engines. However, in terms of technology and the related emission properties, they are years behind in development. Because safety – and therefore the operational security of the engines – is an important priority, especially with seagoing vessels, the petrol engines are adjusted to have a very rich mixture. As a result, CO and VOC emissions are significantly higher than those of comparable engines in road transport. In contrast, NO_x emissions are negligible.

Besides the emissions resulting from the propulsion of inland shipping vessels, emissions of volatile organic compounds (VOC) also take place due to de-gassing of cargo fumes by inland shipping vessels in the Netherlands. The de-gassing of cargo tanks to the atmosphere is often referred to as ventilating, to distinguish this from de-gassing to a vapour processing facility. Although the term does not properly indicate the actual process, in the present report "ventilating" will be used to indicate cargo fumes being released to the outside air. In principle, cargo fumes that remain in a cargo tank after unloading are blown into the air with the use of ventilating fans. This way, the next trip can begin with a clean tank. Partly as a result of government policy, there are exceptions to this process. Cargo fumes that are released when loading ships are classified as part of the emissions of the loading installation and are therefore not included in this report. These emissions are largely allocated to the industrial target group (refineries and chemical industry). The exceptions to this are the loading emissions during ship-to-ship transfer.

The emission calculation includes 30 different VOC species. The basis for this assumption is the transported quantity of other volatile organic substances and a rough estimate of the emission factors of these substances. They do not include the following:

- The emissions of cargo fumes via pressure release valves;

- Incidental emissions from cargoes to water or air resulting from accidents or careless handling;
- Emissions of fuel vapours from fuel storage tanks.

5.2 Activity data and (implied) emission factors

Different methodologies are used for calculating the emissions from freight shipping, passenger vessels and recreational craft. The methodologies are described below.

5.2.1 Professional inland shipping

The methodology for calculating the emissions of professional inland shipping has been developed as part of the so-called EMS-project (Emissions Monitoring Shipping). This project has been implemented on behalf of the Ministry of Transport, Public Works and Water Management, coordinated by DG for Public Works and Water Management, and executed by TNO among others. The emission calculation is based on the energy consumption per vessel class, which is derived from the travelled vessel kilometres. For 31 vessel classes, the power demand (kW) is calculated for the various inland waterway types and rivers in the Netherlands. A distinction is made between loaded and unloaded ships. In addition, the average travel speed of the various vessel classes in relation to the water, is assessed depending on the vessel class and the maximum speed allowed on the route that is travelled.

The general formula for calculating emissions is as follows:

Emissions = Number . Power . Time . Emission factor

Emissions from propulsion engines =
the sum of vessel classes, cargo situations, routes and directions of:
 {number of vessel passages times
 average power used times
 average emission factor times
 length of route divided by speed}

or

$$E_{v,c,b,r,s,d} = N_{v,c,b,r,d} \cdot P_{b,v,b,r} \cdot L_r / (V_{v,r,d} + V_r) \cdot EF_{v,s} \quad (1)$$

Where:

$E_{v,c,b,r,s,d}$ = Emission per vessel class, (kg)
 $N_{v,c,b,r,d}$ = Number of vessels of this class on the route and with this cargo situation sailing in this direction
 $P_{b,v,b,r}$ = Average power of this vessel class on the route (kW)
 $EF_{v,s}$ = Average emission factor of the engines of this vessel class (kg/kWh)
 L_r = Length of the route (km)
 $V_{v,r}$ = Average speed of the vessel in this class on this route (km/h)
 V_r = Rate of flow of the water on this route (km/h), (can also be a negative value)

v,c,b,r,s,d = indices for vessel class, aggregated cargo capacity class, cargo situation, route, substance, and direction of travel, respectively

The formula in the box above is used for calculating the emission of substance (s) in one direction (d) specifically for one vessel class (v,c), loaded or unloaded (b), on every distinct route (r) on the Dutch inland waterways. The combination of the number of vessels, their power and their speed is the explanatory variable for emissions. The unit of the explanatory variable for emissions is "kWh". The emission factors are

expressed in “kg/kWh”, the same unit that is used to express emission standards. The emission factors are dependent on the engine’s year of construction.

For calculating the above emission formula, a calculation model has been developed.. The calculation protocols and backgrounds of the EMS form the basis of the emission calculations. The complete set of protocols (in Dutch) can be found on the website of the Dutch Emission Registration (www.emissieregistratie.nl).

The complete detailed activity data for the calculation as described in formula 1 is only available for the year 2008. For the annual emission calculations of professional shipping the figures are scaled using CBS data on the number of vessel kilometres per vessel class, subdivided to national and international shipping transport. The diagram below shows how the scaling is executed. The scaling factors are calculated per CBS ship size class and load. Calculation of emission factors is discussed below.

In 2012, the 2008 input data of the BIVAS model of the department of Waterways and Public Works have been used for the detailed distribution of ship types over the waterways. These data have been applied as basis for the calculation of the energy consumption from 2005 onwards (Hulskotte, & Bolt 2012). For earlier years the original EMS data are still used.

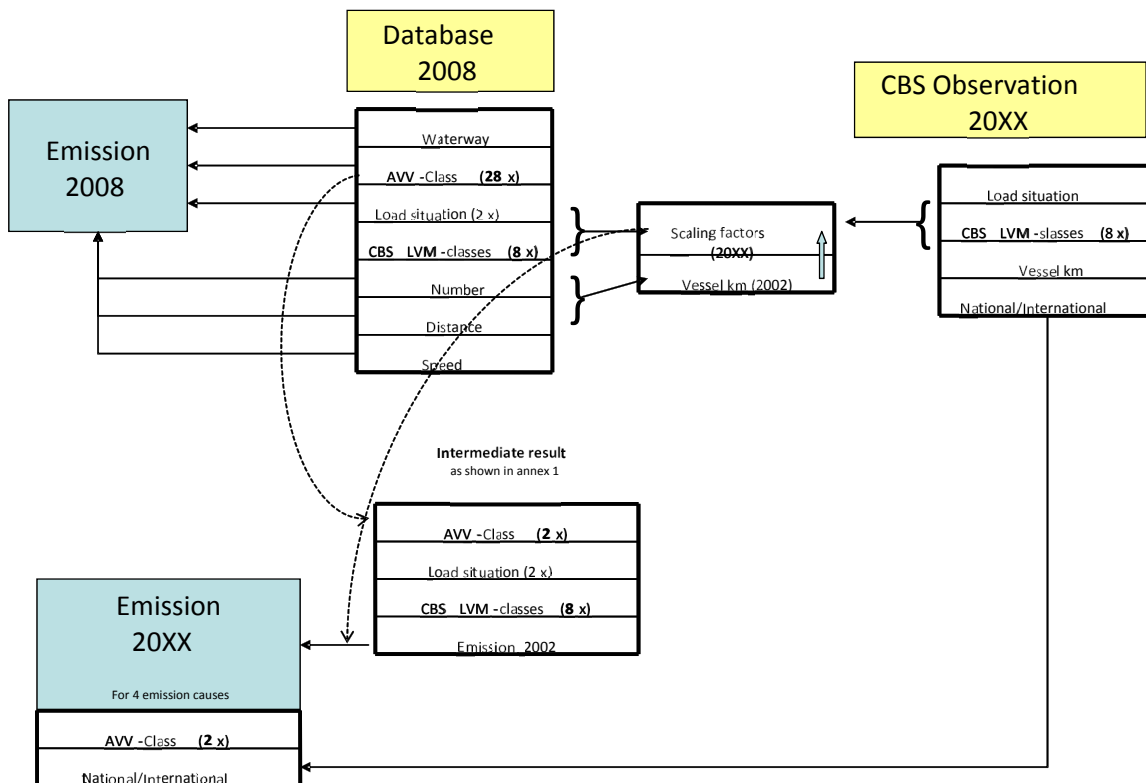

In the EMS-protocol for inland shipping, a distinction is made between primary engines and auxiliary engines. Primary engines are intended for propelling the vessel. Auxiliary engines are required for manoeuvring the vessel (bow propeller engines) and generating electricity for the operation of the vessel and the residential compartments (generators). The protocol does not include:

- the emissions of passenger transport, recreational boat transport and fisheries,
- emissions originating from the cargo or sources other than the engines,
- emissions of substances other than those listed above.

The methodology for determining the emission factors for professional inland shipping is described in the EMS protocol for inland shipping (Hulskotte & Bolt, 2012). Tables 5.2 through 5.6 show the implied emission factors for professional inland shipping expressed in grams per kg of fuel for CO, VOC, NO_x and PM₁₀.

The average emission factor is determined by a distribution of ship engines over the various year of construction classes to which emission factors have been linked. This distribution is calculated by means of a Weibull function.

The general formula of the Weibull function is the following:

$$f(x; k, \lambda) = \frac{k}{\lambda} \left(\frac{x}{\lambda}\right)^{k-1} e^{-(x/\lambda)^k}$$

The values of the Weibull parameters (κ and λ) have been derived from sample survey by telephone carried out by TNO among the shipmasters of 146 inland in use vessels. They were asked about the age of the ship and the age of the ship’s engine. In the calculations the following values have been used: x = age/10 and x has been varied between 1 and 7. By means of a smallest square estimate the optimal values for κ en λ have been determined to be 1.2 and 1.3.

The median age (the age when 50% has been replaced) can be calculated through the formula:

$$\lambda \ln(2)^{1/k}$$

The result has to be multiplied with 10 as x has been entered as age/10 into the formula. In that case the median age of the vessels, according to the formula, is 9.6 years. The median age of the engines in the survey was 9,0 years and the average age was 14.9 years. The distribution of year of construction classes calculated with the Weibull function is shown in a graph:

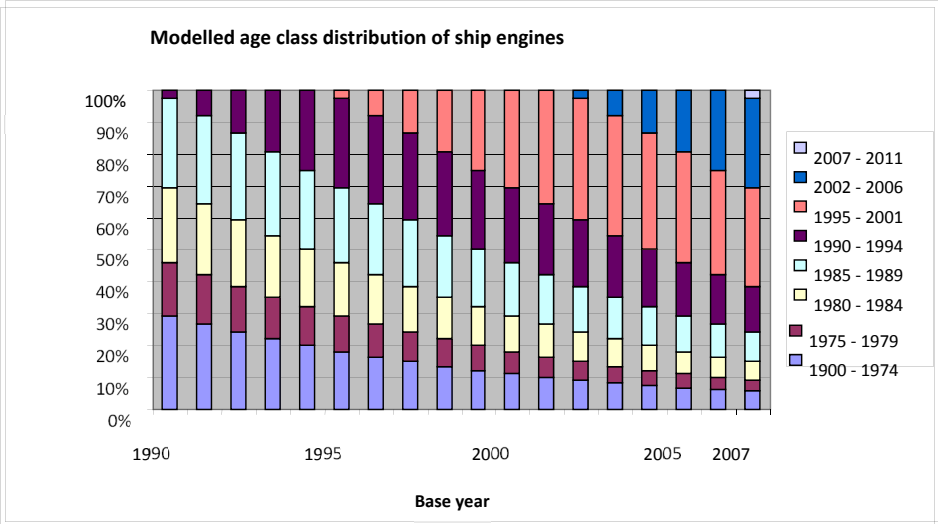

The following graph shows that the modelled age of ship engines is much more realistic than obtained from the IVR ship database:

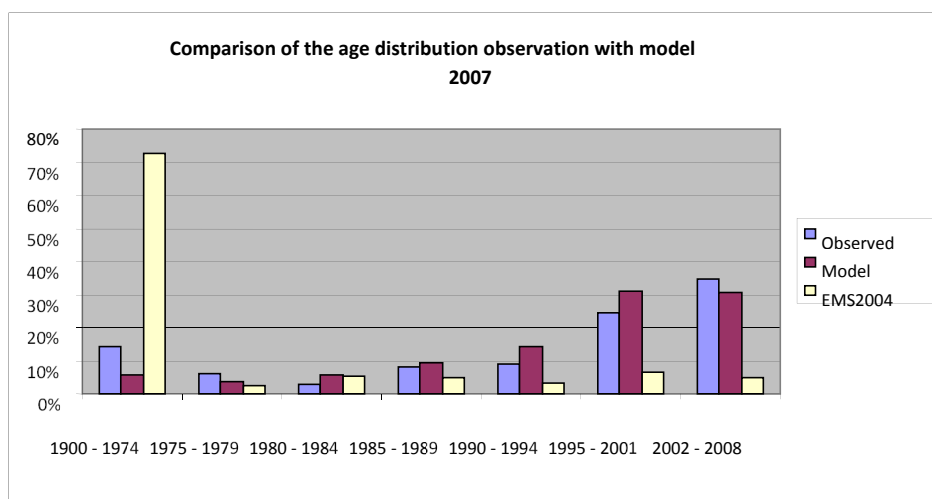

It has been decided to calculate with a formula instead of an observed distribution because this option gives more flexibility with respect to the calculation of future emissions and future year of construction classes. In case of emission factors for the calculation of cargo fumes references are made to the protocol on this subject, drawn up within the framework of the EMS project (Bolt, 2003) and which was updated by the Buck et al. (2013).The resulting fuel consumption for inland navigation is shown in *Table 5.1*.

Emission factors for the combustion of motor fuels; SO₂ and heavy metals

The emission factors for SO₂ and heavy metals have been derived from the sulphur and heavy metal content of the motor fuels. The sulfur content is shown in table 10 of the EMS protocol for inland shipping (Hulskotte & Bolt 2012). The metal content of diesel is shown in *Table 5.6*

PM_{2,5} emissions are calculated from PM₁₀ by using an emission profile (see *Table 5.8*). The calculation of the combustion emissions of VOC and PAH components, including methane, also takes place using profiles. First the combustion emissions of VOC are calculated. The profiles indicate the fractions of the various VOC and PAH components in total VOC. By multiplying total VOC emissions with the fractions from these profiles, the emissions of individual VOC and PAH components are estimated. The emissions of heavy metals are calculated by multiplying the fuel consumption with the emission factors that are based on the metal content of the marine fuels. The emission factors, expressed in grams per kg of fuel, are shown in *Table 5.6*. The emission profiles for VOC and PAH components are shown in *Table 5.7*.

5.2.2 Passenger ships and recreational craft

There is no recent data on the number of passenger ships or the energy use by passenger ships in the Netherlands, therefore the fuel consumption figures for 1995 are applied for all years afterwards.

For recreational craft, the emissions are calculated by multiplying the number of recreational boats (allocated to open motor boats/cabin motor boats and open sailboats/cabin sailboats) with the average fuel consumption per boat type times the emission factor per substance, expressed in emission per engine type per quantity of fuel. The various types of boats are equipped with a specific allocation of engine types that determine the level of the emission factors.

The emission factors are measured in quantities of emission per quantity of generated kinetic energy. By dividing them with the specific fuel consumption (fuel quantity required per unit of generated kinetic energy), an emission factor per quantity of fuel is obtained. The implied emission factors for recreation craft (in grams/kg fuel) are also shown in *Tables 5.2 through 5.6*.

The methodology for calculating emissions to water from recreation craft is described in Deltares & TNO (2016).

5.2.3 De-gassing cargo fumes to the atmosphere

The calculation of the emissions resulting from de-gassing of cargo fumes are conducted for each substance using the following formula:

$$\text{Weight of VOC (vapour) emitted} = \text{mass of unloaded cargo (A)} * \text{percentage after which the hold is ventilated (B)} * \text{evaporation factor (C)}$$

The required data fall into three categories:

- Transport data, originating from statistical information;
- Data about the practice of loading and unloading (also linked partially to regulations);
- Chemical and physical data, originating from the relevant literature.

In this formula, the weight of the unloaded cargo is the explanatory variable for emissions. The emission factor is arrived at by multiplying the evaporation factor with the percentage of the unloaded cargo after which the hold is ventilated. A comprehensive description of the methodology can be found in the protocol established as part of the EMS project (Bolt 2003), or more recently in De Buck et al. (2013).

5.3 Uncertainties

The uncertainties in emission estimates have been derived from the uncertainty in activity data and emission factors in accordance with the rule that the uncertainty of the product of two uncertain factors is equal to the greatest uncertainty of one of the two factors, therefore:

- $A * A = A$
 - $A * B = B$
 - $B * A = B$
 - $C * C = C$
 - $A * D = D$
- etc.

The results are shown in the Appendix.

5.4 Points for improvement

The fuel consumption estimates of passenger boats and ferries have not been updated since 1994 and should be re-evaluated. The reliability of the data concerning the number of recreational boats and the number of hours of their usage on the waterways is low.

Weak points of engine emissions in professional inland waterway shipping

The amount of vessel movements on the rivers Waal and IJssel in particular should be improved.

Weak points concerning cargo fumes emissions

Important uncertainties are the following:

- What is the subdivision according to individual substances within the “not named elsewhere” classes, or remainder categories?
- What is the percentage of loading cycles with a compatible substance where degassing is actually avoided because a vapour processing facility is available and is being used?
- What percentage of the loading does not take place directly onshore?
- Which saturation factor must be used for emptied tanks, and how large are the cargo residues that can still evaporate?

Most important points of improvement for motor emissions in professional inland shipping

It is recommended to implement the annual derivation of the table with shipping movements by using software that is specially developed and tested for this purpose. When the observations of ship movements on the rivers Waal and IJssel are inadequate for this software also, new information sources are needed in view of the large share of this shipping route in the national total.

Most important points of improvement for cargo fumes emissions

Besides more reliable data from practice about the emission factors, there should be harmonization with the calculation method that is used for VOC emissions in the industrial target group. The calculated emissions must be consistent and it must be clear which emissions are attributed to shipping and which are attributed to industry. The calculation proposed here makes a distinction between different sequential cargoes, which is an important piece of information not only when determining emissions, but also the effects of policy measures.

6 Fisheries

6.1 Source category description

The Fisheries source category covers emissions from fishing activities in the Netherlands, including inland fishing, coastal fishing and deep-sea fishing. Diesel engines are used to propel fishing vessels such as deep-sea trawlers and cutters, and to generate electrical power on-board fishing vessels. These diesel engines can be fuelled with either diesel oil (distillate) or residual fuel oil. The combustion process that takes place in these diesel engines causes emissions of greenhouse gases and air pollutants.

Emissions of air pollutants from fishing are reported under source category 'Fishing' (1A4ciii) in the NFR. This includes emissions resulting from all fuel supplied to commercial fishing activities in the Netherlands. For air quality modelling purposes, emissions of air pollutants from fishing activities on Dutch national territory, including the Dutch Continental Shelf, are estimated separately.

6.2 Activity data and (implied) emission factors

In order to calculate emissions of air pollutants from fishing vessels, total fuel consumption per type of vessel is estimated by the Agricultural Economics Research Institute (LEI). This includes fuel consumption for fishing cutters and deep sea trawlers (both Dutch and foreign). The consumption of diesel oil by Dutch fishing cutters is published in the annual report "Visserij in cijfers" (Taal et al., multiple years) with the aid of the business information network (BIN) of the LEI. The method of data collection and processing for the other vessel types is explained in greater detail here because until now nothing has been published about this method.

A widely-applied method to determine fuel consumption by fishing vessels, which is also used in this report, can be described as follows:

Fuel taken onboard per fishery method = the sum of hp-days x fuel consumption per hp per day per vessel.

Where:

hp-days = number of days a vessel spends at sea x the number of horsepower (on average) of the vessel.

This method is used for fishing cutters as published in "Visserij in cijfers". *Table 6.1* shows the resulting fuel consumption figures that were used for the emission calculations. With the help of data from VIRIS (fishery database from LEI), the ports of departure, ports of arrival and total number of days at sea have been ascertained for each vessel for each fishing trip. When determining where fuel is taken on board, it is assumed that for all fishing trips where the port of departure and arrival were both in the Netherlands, fuel was taken on board in the Netherlands. In all other cases, it has been assumed that the vessels have taken on fuel elsewhere. The basic assumption is that the vessels always refuel after completing a fishing trip.

For all vessels with Dutch ownership interests sailing under another flag and "real" foreign vessels, it has been determined what the installed main engine capacity was in 2002. Data about foreign vessels from VIRIS (LNV, 2004) or the *Gids Van Visserijvaartuigen* (LNV, unknown) – already known to the LEI – were used to determine this. In addition, supplementary data was collected from the website of www.ShipData.nl. In this way the installed engine capacity on the foreign vessels can be ascertained, and an estimate can be made if necessary.

The average fuel consumption figures per day at sea of the various main engines as installed on Dutch deep-sea trawlers have been used as a guide for estimating the fuel intake of approximately comparable deep-sea trawlers registered in other countries with Dutch ownership interests and foreign deep-sea trawlers. In

this way, a good estimate can be made of the fuel consumption per vessel and therefore of the fuel intake per vessel in the Netherlands.

In order to estimate the fuel consumption on the Dutch continental shelf, the estimated fuel consumption by the Dutch cutter fleet was used. This concerns the up-scaled results of a survey of 30% of the fleet of Dutch fishing cutters that are reported in the publication of the LEI titled "*Visserij in Cijfers* (LEI, multiple years). The LEI estimates that approximately 75% of this fuel consumption takes place on the national continental shelf, but that there are still other types of Dutch and foreign fishing vessels on the national continental shelf. It is assumed that the total fuel consumption by Dutch and foreign fishing vessels on the national continental shelf is equal to the total fuel consumption by the Dutch cutter fishery (therefore both on and outside the national continental shelf).

The emission factors that are used to calculate emissions of air pollutants of sea and coastal fishing are for the most part derived from Hulskotte & Koch (2000). The emission factors are shown in *Table 6.2*. PM_{2,5} emissions are calculated as a fraction of PM₁₀ emissions, as shown in *Table 6.3*. The emission factors for heavy metals are assumed equal to the factors used for seagoing shipping (see *Table 7.7*).

Emissions from different VOC and PAH components are calculated using the species profiles as were used for inland navigation, as in *Tables 5.7A* and *5.7B*.

6.3 Uncertainties

The uncertainties in emission estimates have been derived from the uncertainty in activity data and emission factors in accordance with the rule that the uncertainty of the product of two uncertain factors is equal to the largest uncertainty in one of the two factors, therefore:

- $A * A = A$
- $A * B = B$
- $B * A = B$
- $C * C = C$
- $A * D = D$
- etc.

The results are listed in the Appendix.

6.4 Points for improvement

The emission factors for air pollutants have not been updated recently and need to be reassessed.

7 Maritime navigation

7.1 Source category description

Maritime navigation includes emissions from seagoing ships in the Netherlands and on the Dutch part of the Continental Shelf. Emissions result from the use of fuel in the main engines of the ships and in auxiliary engines. The main engines are used for propelling the vessel. Auxiliary engines are required for manoeuvring (bow propeller engines) and generating electricity for operations such as loading and unloading and housing workers or passengers (in the case of ferryboats). Generating electricity in harbours takes place using diesel engines and, in the case of large seagoing vessels, also boilers.

The propulsion of seagoing vessels on routes within the national continental shelf, other route-linked shipping channels on Dutch territory and generating electricity in harbours takes place primarily with the aid of diesel engines. Other engines using fossil fuels, which are seldom applied, are gas turbines and steam engines. The combustion processes that take place in these engines cause emissions of air pollutants. The most important substances released are NO_x, particulate matter, CO, VOC and SO₂. CO₂ and SO₂ are caused by the oxidation of the carbon and sulphur present in the fuel through combustion. Emissions of these substances are therefore completely dependent on the contents of carbon and sulphur in the fuel and the quantity of fuel that is combusted.

Nitrogen oxides (NO_x) are primarily caused by the high temperatures and pressures in combustion engines, which cause the nitrogen present in the atmosphere to combine with oxygen. CO, VOC and PM₁₀ are products of incomplete combustion. The emissions of the latter substances therefore depend primarily on the technological properties of the engines and the way in which these engines are used. PM₁₀ emissions are also correlated with the sulphur content of the fuels used.

Emissions of air pollutants from maritime shipping in the Netherlands are reported under Source category 'International maritime navigation' (1A3di(i)) in the NFR. This includes emissions from all maritime shipping on Dutch territorial waters, excluding fishing which is reported separately in the inventory. Emissions from international maritime shipping are not included in the national emission totals but are reported as a memorandum item.

7.2 Activity data and (implied) emission factors

The methodology for calculating exhaust emissions from maritime navigation in the Netherlands was originally developed in the framework of the so-called EMS-project (Emission Monitoring Shipping), which was conducted by TNO and other organizations on behalf of the Ministry of Transport, Public Works and Water Management in 2003. This methodology is described in detail in the EMS-protocols, that can be downloaded from the website of the E-PRTR (www.emissieregistratie.nl). Activity data for the methodology was originally derived from Statistics Netherlands (number of visiting ships per harbour per year) and from Lloyds Fairplay (vessels movements on the Dutch part of the North Sea). This methodology is applied for calculating emissions in the 1990-2007 period of the time series.

Since 2008, fuel consumption and the resulting emissions of air pollutants by maritime shipping on the Netherlands Continental Shelf, the 12-mile zone and the port areas in the Netherlands are calculated annually by MARIN and TNO (MARIN 2016). Data on ship movements are derived from AIS transponders (Automatic Identification System). Since 2005 all trading vessels larger than 300 GT (Gross Ton) are equipped with an Automatic Identification System (AIS). AIS systems continuously transmit ship information such as destination, position, speed and course. Statistical information such as the name of the ship, the IMO number, ship type, size, destination, and draught are transmitted every 6 minutes. Dynamic information such as position, speed and course are transmitted every 2 to 6 seconds. The AIS data for ship movements on Dutch territorial waters is derived annually from the Netherlands Coastguard. The Dutch

coast guard collects AIS signals from all receiving stations at a continuous basis. The methodology to derive fuel consumption and emissions from the activity data has remained unchanged, and is described below. The methodology distinguishes between ships at sea, ships manoeuvring in harbours and ships at berth.

7.2.1 Emissions of sailing sea-ships

The calculation method for sailing vessels based on AIS data, is uniform for all distinguished areas and all sailing speeds. The calculation is performed by multiplying emission factors derived per individual vessel by the covered distance of the specific vessels on Dutch territorial waters (formula 1).

$EM_{v,g,s,m}$	=	$\sum_i (EF_{v,g,s,m,i,t} \cdot D_{i,a,t})$	(1)
Where:			
$EM_{v,g,s,m,t}$	=	Emission of substance per vessel type v, size class g, engine type m in area a at point in time t, (kg)	
$EF_{v,g,s,m,i,t}$	=	Emission factor substance (s), individual vessel i with vessel type v and size class g and engine type m, point in time t, kg/mile)	
$D_{i,a,t}$	=	Covered distance vessel i in area a	
i,v,g,a,m,s,t	=	Respective index for vessel, vessel type, size class, area, engine type, substance, point of time	

In order to determine the distance covered ($D_{i,a,t}$), the vessel speed and position is derived from the AIS data every two minutes for each vessel. The covered distance in two minutes equals the vessel speed (in miles) divided by 30 (60/2). Before AIS-data became available, the distance covered by various ships in Dutch waters was derived from vessel movements records of Lloyds Fairplay and the SAMSON route network.

For vessels with only one main engine, it is assumed that 85% of the maximum continuous rating power (MCR) of the engine is required for the vessel to attain its design speed. This assumption is based on an inquiry in the Port of Rotterdam under 89 vessels, which resulted in an average value of 83%. This corresponds well with findings of other studies, such as ENTEC (2002) which uses a value of 80% and Flodström (1997) who reports a value of 81% at a realized speed of 93% of the design speed.

At speeds around the design speed, the emissions are directly proportional to the engine’s fuel consumption. At lower operating speeds, less engine power is required. In these light load conditions, the engine runs less efficiently. This leads to an increase in emissions compared to the normal operating conditions. The emission factors are adjusted accordingly, using Formula 2. The emission factors are corrected for the engine power that is assumed to be required for the observed vessel speed (formula 2: CRS). At the same time the emission factors are corrected whenever the engines produce less power (formula 2: CEF).

$$EF_{v,g,s,m,i,t} = EF_{v,g,s,m,i} \cdot CRS_{i,t} \cdot CEF_{p,s} \quad (2)$$

Where:

$EF_{v,g,s,m,i,t}$ = Emission factor substance (s), individual vessel i with vessel type v and size class g and engine type m, point in time t, (kg/mile)

$EF_{v,g,s,m,i}$ = Emission factor substance (s), individual vessel i with vessel type v and size class g and engine type m, not corrected at 85% power, (kg/mile)

$CRS_{i,t}$ = Correction factor for vessel power i At point of time t, (./.)

$CEF_{p,s}$ = Correction factor per substance dependent on the power as %MCR, (./.)

Depending on the engine, specific load correction factors specified per substance can be derived from the EMS protocols. The correction factors applied in the emission calculations for the year 2011 were extended by distinction of different engine types. In order to get more accurate calculations three engine groups were discerned: reciprocating engines, steam turbines and gas turbines. The correction factors (CEF) in formula 2 are shown in *Tables 7.11A-7.11C*. The list was extended by some values provided in the documentation of the EXTREMIS model (Chiffi et al. 2007). The correction factors at MCR over 85% are assumed to be 1. The emission factor corrections exclusively apply to the emissions factors for main engines and not to the emission factors for auxiliary engines, which are derived separately from the vessel data.

Since steam turbines are predominantly used by LNG-carriers, two types of fuels were assumed to be consumed: Boil-off Gas (BOG) and heavy fuel oil (HFO). It was assumed that at lower engine loads (below 30%) engines are mainly operated on HFO. This is expressed in the correction factors for SO₂ and CO₂ (see *Table 7.11B*). On higher loads (above 30%) the average fuel mixture between BOG and HFO is assumed, as derived from (Grose & Flaherty 2007). The correction factors from steam turbines were derived from the EXTREMIS model (Chiffi et al. 2007). Correction factors for gas turbines were estimated with data from the ICAO Aircraft Engine Emissions Databank (UK Civil Aviation Authority 2010). The emission behaviour of the GE CF6-6D (marine derivative: GE LM2500) and the Allison 501 (AN 501) was taken as representative for the two most occurring gas turbines in marine applications (see *Table 7.11C*).

$$CRS_{i,t} = [(V_{i,t,actual}/V_{i,service})^3 + 0,2] / 1.2 \quad (3)$$

Where:

$CRS_{i,t}$ = Correction factor vessel power i At point of time t, (./.)

$V_{i,t}$ = Vessel speed i at point of time t, (knots)

$V_{i,service}$ = Service speed of vessel i, (knots)

i,t = resp. index for vessel and point of time

Formula (3) applies for correcting the power of propulsion engines (CRS). In formula 3 it is taken into account that the power of the main engines during very slow manoeuvring will not drop below 10% of the

MCR. With formula 3 the minimal power of main engines has been limited at 14% ($=0.85 \times 0.2/1.2$) for as the vessel has not come to a standstill. At a value of 1.176 of CRS 100% of MCR is exceeded. This is the case with an exceeding of 107% of the service speed. In the calculations 100% MCR is used as maximum value.

7.2.2 Emissions from seagoing vessels at berth

Fuel consumption by seagoing vessels at berth is calculated by multiplying the time at anchor of visiting vessels, derived from AIS data, by their fuel consumption per unit of time, as determined in two TNO-studies (Hulskotte et al. 2013 & Hulskotte & Matthias 2013). The calculation method developed in the EMS protocol (see formulas 4, 5 and 6) is still being used, with exception of the period at anchor and the anchor location, which are determined on the basis of AIS data. For years 2007 and earlier, no AIS data are available, so the number of ships at anchor where derived from Statistics Netherlands, which reported the annual number of visiting ships per harbour, including vessels types and GT. The average time at anchor based on estimates, as described in Appendix 1 of the EMS protocol.

In the first step of the emission calculation, total fuel consumption is derived based on the size of the vessel, the time at anchor and the specific fuel consumption rate, as is shown in the box below (formula 4).

F_v	=	$V_v \cdot T_v \cdot E_v$	(4)
Where:			
F_v	=	Fuel consumption, (kg)	
V_v	=	Vessel size (GT)	
T_v	=	Time at anchor (hours/visit)	
E_v	=	Rate of fuel consumption (kg/GT.hour)	
v	=	index for type of vessel	

In a second calculation step, total fuel consumption is specified according to fuel type and engine type/boilers (formula 5).

$F_{v,f,m}$	=	$f_{v,f} \cdot f_{v,m} \cdot F_v$	(5)
Where			
$F_{v,f,m}$	=	Fuel consumption per vessel type (v), per fuel(f) and engine type (m),(kg)	
F_v	=	Fuel consumption per vessel type, (kg)	
$f_{v,f}$	=	Fraction of fuel (f) per vessel type (v), (./.)	
$f_{v,m}$	=	Fraction of engines (m) per vessel type (v) (./.)	
v,f,m	=	index for vessel type, fuel, engine type, respectively	

The emissions of air pollutants are subsequently calculated by multiplying (Formula 6) with the emission factors per engine type and fuel type by the fuel consumption as derived from Formula (5).

$EM_{s,v,f,m}$	=	$F_{v,f,m}$. Emission factors _{f,m}	(6)
Where:			
$EM_{s,v,f,m}$	=	Emissions (kg)	
$F_{v,f,m}$	=	Fuel consumption per vessel type (v), per fuel (f) and engine type (m),(kg)	
Emission factors _{f,m}	=	Emission factor per substance (s) fuel (f) and engine type (m), (kg/kg)	
v,f,m,s	=	index for vessel type, fuel, engine type, substance	

The accompanying set of tables contains further information on total fuel use over fuel types in dependence of ship types, the allocation of fuel amount over engine types and apparatus during berth, and the emission factors used (*tables 7.10A – 7.10G*). The resulting fuel consumption for ships at anchor, manoeuvring in ports and sailing on the Dutch part of the Continental Shelf is shown in *Table 7.1*. *Tables 7.2-7.5* show the resulting emissions of CO, VOC, NO_x and PM₁₀. PM_{2,5} emissions are calculated as a fraction of PM₁₀ emissions. *Table 7.9* shows the assumed share of PM_{2,5} in the PM₁₀-emissions.

7.2.3 Exhaust emissions of SO₂, N₂O, NH₃, heavy metals and VOC/PAH components

Since January 1st 2010 the sulphur content of marine fuels used for ships at berth in the EU is regulated to a maximum of 0.1 percent. This implies that only marine gas oil with a sulphur content below 0.1 percent is used in harbours. The specification of fuel types at berth is adapted according to this new regulation. In tanker ships a reduction factor (50% for PM and 90% for SO₂) is applied to the emission factors for boilers, because gas scrubbers are often applied in order to protect ship internal spaces from corrosion by inert gases produced by boilers.

Sulphur content from ships at the North Sea is also regulated. In 2007, the North Sea was designated as sulphur oxide emission control area (SECA). The sulphur limit for the fuels used on the North Sea decreased from 1.5% in 2007 to 1% in 2010. This is taken into account in the emission calculation. From 2015 onwards, the sulphur limit is set at 0.1%. By lack of enforcement observations a compliance rate of 50% was assumed on the Netherlands Continental Shelf. The SO₂ emission factors for diesel oil and heavy fuel oil used at anchor and while sailing are shown in *Table 7.6*.

The emissions on Dutch territory of N₂O and NH₃ are calculated by using default emission factors for N₂O (IPCC 2006) and NH₃ (Ntziachristos and Samaras, 2000), as shown in *Table 7.7*. These emission factors have been multiplied by the total fuel consumption of seagoing ships on Dutch territory as calculated using the methodology described above. The emissions of heavy metals are calculated by multiplying the fuel consumption with the emission factors that are based on the metal content of the marine fuels. The emission factors, expressed in grams per kilogram of fuel, are shown in *Table 7.7*.

The calculation of the combustion emissions of VOC and PAH components, including methane, takes place using species profiles. The VOC and PAH profiles have been ascertained by VROM (1993), see *Tables 7.8A, B and C*. First, as discussed above, the combustion emissions of VOC are calculated. The species profiles subsequently indicate the fractions of the various VOC and PAH components in total VOC. By multiplying total VOC emissions with the fractions from these profiles, the emissions of individual VOC and PAH components are estimated.

7.3 Uncertainties

The uncertainties in emission estimates have been derived from the uncertainty in activity data and emission factors in accordance with the rule that the uncertainty of the product of two uncertain factors is equal to the largest uncertainty in one of the two factors, therefore:

- $A * A = A$
 - $A * B = B$
 - $B * A = B$
 - $C * C = C$
 - $A * D = D$
- etc.

The results are shown in the Appendix.

7.4 Points for improvement

Seagoing vessels at anchor

The fuel consumption of vessels at anchor is not linear to the size of the vessels. The determination of non-linear correlations between the vessel size and fuel consumption could lead to an improvement of the results.

Sailing and manoeuvring seagoing vessels on Dutch territory

- Implementing measurements in practice concerning particulate matter emissions from seagoing vessels that burn heavy fuel oil.
- Determine the possibility of conducting a systematic data collection on the sulphur content of fuels. To know the extent of the uphold of IMO Annex VI is an important parameter in the calculation of SO₂ and PM emissions.

Seagoing vessels on the national continental shelf

- Implementing measurements in practice concerning particulate matter emissions from seagoing vessels that burn heavy fuel oil.
- The service speed of the vessels should perhaps be modified somewhat to be more in accordance with reality.
- Determine the possibility of conducting a systematic data collection on the sulphur content of fuels.

8 Civil aviation

8.1 Source category description

Civil aviation includes all emissions from national and international civil aviation in the Netherlands. This includes emissions from both scheduled and charter flights, passenger and freight transport, air taxiing, helicopter flights and general aviation. Emissions from civil aviation result from the combustion of jet fuel (jet kerosene) and aviation gasoline. Most civil aviation in the Netherlands stems from Amsterdam Airport Schiphol, which is by far the largest airport in the country, although some regional airports have grown rather quickly since 2005.

The other airports besides Schiphol can be classified as follows:

- Regional airports: Maastricht, Eindhoven, Rotterdam, Lelystad and Groningen
- Small airfields: Twente, Ameland, Budel, Den Helder, Hilversum, Hoogeveen, Midden-Zeeland, Noordoostpolder, Seppe, Teuge, Texel and Drachten.

Emissions of air pollutants from civil aviation in the Netherlands are reported under Source category 1A3ai(i) (International aviation LTO (civil)) in the NFR, as is shown in Table 8A. This includes emissions during the Landing and Take-Off Cycles (LTO-cycle) from all departures and arrivals in the Netherlands from both national and international aviation. It also includes particulate matter emissions from tyre and brake wear, and emissions from auxiliary power units (APU). Emissions from the storage and transfer of jet fuel are only calculated for Amsterdam Airport Schiphol. Emissions from ground support equipment (GSE) at Schiphol and the regional airports are included in source category *Other, mobile* (1A5b). Cruise emissions of air pollutants of domestic and international aviation (i.e. all emissions occurring above 3.000 ft.) are not part of the national totals and are not estimated. Given the small number of domestic flights, LTO-emissions from domestic civil aviation are not reported separately in the NFR-tables but are included under International Aviation LTO (1A3ai(i)).

In the past rough estimates have been made of the air pollutant emissions from military aviation during the landing and take-off cycle (LTO). As the Ministry of Defence is not allowed to provide detailed figures concerning military aircraft movements, an update of the emissions by military aircraft is not possible. As the current emission figures almost certainly differ a lot from the emissions estimated in the past, it has been decided to discontinue the publication of military emissions during the LTO cycles in the Dutch Emission Registration.

Table 8A Emission reporting for civil aviation in the CRF and NFR

NFR-code	Source category	Flight stage	Reported under
1A3ai(i)	International aviation LTO (civil)	LTO only	National emission totals
1A3aii(i)	Domestic aviation LTO (civil)*	LTO only	National emission totals

*) Domestic aviation is included under 1A3ai(i) International aviation

8.2 Activity data and (implied) emission factors

The emission calculations for civil aviation are performed with the CLEO model created by TNO. The model uses activity data and emission factors to calculate the emissions of civil aviation from the various sources described above. The emission calculations for the individual sources are explained below. A more detailed description of the CLEO model is available in Dellaert & Hulskotte (2017).

8.2.1 Exhaust emissions at Amsterdam Airport Schiphol

The exhaust emissions of CO, VOC, NO_x, PM₁₀, SO₂, CO₂ and lead caused by civil aviation during the LTO are calculated annually using a flight-based Tier-3 methodology. The methodology is derived from the almost universally used method of the US Environmental Protection Agency (EPA), which was later applied by the ICAO in its measurement protocols for aircraft engines. The model is based on the four flight modes of the LTO-cycle. The LTO cycle comprises four stages: taxiing (Idling), starting (Take-off), climbing to 3000 feet (Climb-out) and descending from 3000 feet (Approach). Emissions that occur above 3000 feet (about 1 km) are not included in the emission calculations. Each flight mode corresponds with specific engine settings (Power settings) of the aircraft (Idle: 7%, Take-off: 100%, Climb out 85%, Approach 30%). These power settings result in specific fuel consumption per unit of time. For each engine type, the fuel consumption results in a specific emission (emission factor per weight unit of fuel). The equation below shows the calculation of the emission of a specific substance during one year.

$$EMISSION_y = \sum_{p,m,f} LTO_{p,m} \cdot N_p \cdot FUEL_{m,f} \cdot TIM_{p,f} \cdot EF_{m,f}$$

Where:

- $Emission_y$ = Emission of a specific substance in a specific year (kg/year)
- $LTO_{p,m}$ = Number of Landing and Take-off Cycles per aircraft type (p) with motor type (m) per year; (1/y)
- N_p = Number of engines per aircraft (p);
- $FUEL_{m,f}$ = Fuel consumption of engine (m) in flight mode (f); (kg/s)
- $TIM_{p,f}$ = Duration (abbrev. of Time in Mode) of flight phase (f) for aircraft (p); (s)
- $EF_{m,f}$ = Emission factor of engine (m) per quantity of fuel in flight mode (f); (kg/kg)

The annual number of flight movements per aircraft type serves as the input for the emission calculations. Statistics Netherlands provides annual data for the number of aircraft movements by aircraft type at Dutch airports (CBS, 2016b). Furthermore, the StatLine databank of Statistics Netherlands provides figures about the total number of aircraft movements at Dutch airports beginning in 1990 (CBS, 2016a). The “Statistical Annual Review” of Schiphol Airport is also used for the flight movements at Schiphol Airport in the years before 2005 (Amsterdam Airport Schiphol, several years). The aircraft types were derived from their ICAO-codes and allocated to the appropriate type present in the CLEO model (ICAO, 2016a). When, for a specific airport, no aircraft types were available for a certain year, the fleet composition of the previous year was used combined with the total number of flights as reported by Statistics Netherlands.

Approximately 400 aircraft types are distinguished in the CLEO model. According to the “Statistical Annual Review” of Schiphol Airport, these include the 40 most frequently appearing aircraft types at Schiphol. The allocation of the aircraft engines to the types of aircraft appearing at Schiphol Airport is based primarily on the aircraft-engine combinations in use by the “Home carriers” at Schiphol such as KLM. For smaller (piston-engine) aircraft, the Dutch aircraft register was used to see which type of engine was most often equipped by a certain aircraft type in the Netherlands (Ministerie van Infrastructuur en Milieu, 2016).

The duration of the flight modes (except the Idle mode) were derived from the US EPA (1985). The average taxi/idle time (Idle) was calculated based on measurements conducted by the airport (Nollet, 1993) and the RLD₃ for taxi times per individual runway combined with the usage percentages per runway. For heavier aircraft (JUMBO class) a separate TIMCODE category (TIM = Time In Mode) was introduced with somewhat longer times for the flight modes Take-off and Climb-out. This information was obtained at that time from the RLD. The duration of the IDLE phase in the calculations has been set to 760 seconds for all aircraft types on all other airports. *Table 8.10* shows the TIM times and TIM categories adapted for Schiphol Airport. In the CLEO model, the time of the idle mode can be varied for the aircraft falling under TIMCODE categories

JUMBO, TF, TP and TPBUS, which is virtually equivalent with the aircraft movements of all commercial air transport.

The fuel consumption per unit of time during the different stages of the LTO cycle, along with the accompanying fuel-related emission factors, are known for virtually all important aircraft-engine combinations. *Table 8.1* shows the fuel consumption figures. The CO₂ emissions during the LTO-cycle are derived from the fuel consumption. The emission factors for the air pollutants are determined. Most emission factors used in the CLEO model have been derived from the [ICAO Engine Emissions DataBank](#) (ICAO, 2016b) and from CAA (CAA 2008). The majority of data in this database was measured as part of the certification of aircraft engines with a thrust greater than 30 kN. During this process, a standard measurement protocol is used that is prescribed by the ICAO (several years). The CLEO model also contains a number of emission factors for smaller (piston) engines. The sources for these emission factors are a report by the Swiss Federal Office for Civil Aviation (Rindlisbacher et al., 2007), and the EPA's AP42 publication (EPA, 1985). Furthermore, emission factors of aircraft with turboprop engines have been added to the CLEO model. These factors were gathered by the Swedish FFA in the so-called Hurdy-Gurdy-database (FFA, 1996). For the year 2013, *Tables 8.9A and 8.9B* provide the resulting emission factors per type of aircraft for a large number of engine type-aircraft type combinations frequenting Dutch airports. These tables, with an aggregation of the factors for each flight mode, provide an indication of the variations for each aircraft type. For current data, the ICAO emissions databank ([ICAO Engine Emissions DataBank](#)) can be consulted. The resulting (implied) emission factors for CO, VOC, NO_x, PM₁₀ and CH₄ are shown in *Tables 8.2 through 8.6*.

Per group of aircraft engines the PM emission factors are calculated from 'Smoke Numbers' according to the method described in a Eurocontrol report (EEC/SEE/2005/0014, eq. 8, p.69) (Kugele et al., 2005). Afterwards the figures have been doubled because of the OC-fraction in aircraft-PM (Agrawal et al., 2008). PM_{2.5} and EC_{2.5} emissions are calculated from PM₁₀ by using an emission profile (*Table 8.11*).

Emissions from helicopters are calculated based on a study (Rindlisbacher 2009) that provides emission factors specified by flight phase of most commercial helicopters that are in use nowadays.

The calculation of the combustion emissions of VOC and PAH components, including methane, takes place using VOC and PAH species profiles, as shown in *Tables 8.8A and 8.8B*. First, as described above, the combustion emissions of VOC are calculated. The profiles indicate the fractions of the various VOC and PAH components in total VOC. By multiplying total VOC emissions with the fractions from these profiles, the emissions of individual VOC and PAH components are estimated.

Emissions of lead and SO₂ are directly related to the characteristics of the fuel type used. For jet fuel, emission factors of SO₂ are based on the EMEP/EEA guidebook (EMEP/EEA, 2016). For AvGas, the SO₂ emission factors are based on the Dutch SO₂ emission factors for petrol (see *Table 3.24*). The emission factor for lead is estimated based on the lead content of AvGas 100LL, which is the most commonly used fuel type for piston engines. Note that in recent years unleaded types of AvGas have been introduced which potentially reduce the lead emissions of AvGas fuelled aircraft. However, since there are no statistics available on the use of these unleaded fuels, their inclusion in the model remains a point of improvement. The SO₂ and lead emission factors are shown in *Table 8.14*. Other metal emissions are assumed to be negligible.

8.2.2 Emissions from tyre and brake wear

The PM emissions from tyre and brake wear are calculated for Schiphol and the regional airports. The calculation is based on the number of take-offs and average emission factors based on the Maximum permissible Take-off Weight (MTOW). This methodology is described by British Airways (Morris 2007). The emission factors can be found in *Table 8.13*.

$$Emissions_y = MTOW_y * EF_{tyre}$$

$$Emissions_y = MTOW_y * EF_{brake}$$

Where:

Emission _y	= Emission of a specific substance in a specific year; (kg/year)
MTOW _y	= Total summed MTOW of aircraft LTO's; (tonne/y)
EF _{tyre}	= PM emission factor for tyre wear; (g/t MTOW)
EF _{brake}	= PM emission factor for brake wear; (g/t MTOW)

8.2.3 Emissions from auxiliary power units

The emissions of Auxiliary Power Units (APU) in aircraft are calculated based on the estimated quantity of fuel that is consumed during power generation. Information on the type of APU that is installed in specific aircraft types is taken from a report for the Global Atmosphere Division of DEFRA (Netcen, 2004), while emission factors and fuel use for these APU types were also taken from this report and data from KLM (KLM, 2016).

The typical APU running time between landing and take-off may differ per aircraft type and airport. To limit APU emissions, several airports limit the allowed running time of APU's and require aircraft to use fixed electricity connections and preconditioned air instead. Especially Schiphol airport has introduced stricter rules concerning APU use. Since this is also the largest airport, the model includes year dependent APU running times for Schiphol Airport, while for the other airports a default running time of 45 minutes per LTO cycle is assumed based on the value for short-haul aircraft operation in the ICAO airport air quality manual (ICAO, 2011).

APU emissions for the applicable aircraft types are calculated using the following equation:

$$Emission_y = \sum_{apu} LTO_{apu} * FUEL_{apu} * TIME_{airport} * EF_{apu}$$

Where:

Emission _y	= Emission of a specific substance in a specific year; (kg/year)
LTO _{apu}	= Number of LTO cycles per APU type per year; (1/y)
FUEL _{apu}	= Fuel consumption of APU; (kg/s)
TIME _{airport}	= Duration of APU use per LTO at airport; (s)
EF _{apu}	= Emission factor of APU per quantity of fuel; (kg/kg)

8.2.4 Emissions from ground support equipment

Emissions of ground support equipment (GSE) at Schiphol Airport were estimated by KLM Equipment Services (KES). KES is responsible for maintenance and refuelling of 95% all GSE at Schiphol Airport. Fuel consumption of all individual equipment (more than 1800 units) is monitored annually. For each unit the emission-category (33 categories) is determined. The equipment engine emission factors are set equal to the EU-emission limit values. A greater part of KLM ground power units have engines that are cleaner than legal emission limit values. Data of the producers measurement reports are applied instead of EU-emission limit values for those GPU's of which emission measurement data from producers are available.

The general formula that is applied by KES in the emission calculation at Schiphol Airport is:

$$Emission (g) = FC (L) * \rho (g/L) / engine-efficiency (g/kWh) * EF (g/kWh)$$

Total annual emissions of GSE at Schiphol Airport were divided by total MTOW of all LTO-cycles in order to determine implied emission factors of GSE:

$$EF_{implied, schiphol} = \Sigma Emission / \Sigma(LTO_{ac} * MTOW_{ac}) \text{ (data from Schiphol Airport)}$$

The implied emission factors can be found in *Table 8.12*. Data for the range of years between 1996 onwards as determined by the methodology described above was delivered by KES (Feldbrugge 2014). For earlier years, the 1996 emission factors are used.

For the regional airports (Eindhoven, Rotterdam, Lelystad, Groningen and Maastricht), the GSE fuel use is estimated based on the total MTOW. Since GSE is mostly needed for larger aircraft, only aircraft with an MTOW larger than or equal to 6 tonnes are counted towards the total MTOW. A factor of 0.41 litre diesel per tonne MTOW is assumed, which is an average calculated based on Schiphol airport. The formula applied to calculate emissions of other airports is:

$$Emission (g) = EF_{implied, schiphol} * \Sigma(LTO_{ac} * MTOW_{ac})$$

8.2.5 Emissions from storage and transfer of jet fuel

Due to expulsion of jet fuel vapour when loading fuel, some jet fuel vapour is released during refuelling. It is assumed that the volume of air that is driven out while tanking is saturated with jet fuel vapour. The emissions are only calculated for Schiphol as the emissions on the other airports are expected to be negligible. The emission factor is based on an environmental report by Aircraft Fuel Supply (AFS), the company which handles all aircraft fuelling and fuel handling at Schiphol airport. A Kerosene Vapour Processing System (KVPS) was installed in 2012, which led to a significant reduction in the emission factor (AFS, 2013).

Expressed as a formula, the calculation appears as follows:

$$EMISSION_y = VOLUME_y * EMISSION FACTOR$$

Where:

$EMISSION_y$	= Emissions (of volatile organic substances) in one year (kg/y)
$VOLUME_y$	= Volume of the total quantity of jet fuel tanked in one year (m ³ /y)
EMISSION FACTOR	= The quantity of hydrocarbons per volume unit (kg/m ³)

8.3 Uncertainties

There is no recent and accurate information available for assessing the uncertainties of the emissions of air pollutants from civil aviation in the Netherlands. The uncertainties in emissions of air pollutants have been derived from the uncertainty in activity data and emission factors in accordance with the rule that the uncertainty of the product of two uncertain factors is equal to the largest uncertainty in one of the two factors, therefore:

- A * A = A
- A * B = B
- B * A = B
- etc.

The results are shown in [Appendix 1](#).

8.4 Points for improvement

Exhaust emissions:

- The values of time-in-modes for various aircraft types may have changed in years due to other configurations of the airport(s) or changed flight procedures (for instance Continuous Descent Approach (CDA) that have been introduced gradually and cause less emissions during Approach). Current time-in-mode values should be re-evaluated.
- In general more accurate data on engine load and time-in-mode could be taken from real flight data. Together with a more accurate calculation of fuel flow, like the Boeing method 2, more accurate emission data can be calculated.
- There is a lack of reliable data on the share of unleaded AvGas that is used annually at airports in the Netherlands. Data on the use of unleaded AvGas types could be used to improve the calculation of lead emissions.
- APU running time for all years and all airports has been estimated based on a few literature values. Year and airport specific data on APU running time could be used to improve the APU emissions calculation.

9 Non-Road Mobile Machinery

9.1 Source category description

Non-Road Mobile Machinery (NRMM) covers a variety of equipment that is used in different economic sectors and by households in the Netherlands. NRMM is typified as all machinery equipped with a combustion engine which is not primarily intended for transport on public roads and which is not attached to a stationary unit. The most important deployment of NRMM in the Netherlands is the use in agriculture and construction, but NRMM is also used in industrial and commercial sectors and for residential purposes. The largest volumes of fuel are used in tillage, harvesting and earthmoving. Furthermore, NRMM is used for nature and green maintenance, such as in lawn mowers, aerator machines, forest mowers and leaf blowers. Emissions from NRMM result from the combustion of fossil fuels and biofuels in the engines of the machinery. NRMM mostly uses diesel fuel, but gasoline and LPG are also used.

The emissions of air pollutants from NRMM are reported under different source categories in the NFR, as is shown in Table 9A. *Table 1.1* shows the contribution of non-road mobile machinery to the national emission totals of both air pollutants and greenhouse gas emissions.

Table 9A Emission reporting for non-road mobile machinery in the NFR

NFR code	Source category description	Economic sectors
1A2gvii	Mobile combustion in manufacturing industries and construction	Industry, construction
1A4aai	Commercial/Institutional: Mobile	Commercial
1A4bii	Residential: Household and gardening (mobile)	Residential
1A4cii	Agriculture/Forestry/Fishing: Off-road vehicles and other machinery	Agriculture

9.2 Activity data and (implied) emission factors

The emissions of air pollutants from NRMM are calculated using a Tier-3 methodology, except for emissions of NH₃ which are calculated using a Tier-1 methodology.

9.2.1 Activity data

Fuel consumption by mobile machinery in the different economic sectors is not reported separately in the Energy Balance. Therefore, fuel consumption and resulting emissions from NRMM are calculated using a modelling approach, developed by TNO (Hulskotte & Verbeek 2009). The so-called EMMA model uses sales data and survival rates for different types of machinery to estimate the active NRMM fleet. Combined with assumptions on the average use (annual operating hours) and the fuel consumption per hour of operation for the different types of machinery, the total fuel consumption of NRMM is estimated. The methodology used in the EMMA model is similar to the methodology used in the EPA NON-ROAD USA model by the US Environmental Protection Agency (EPA), as described in Harvey et al. (2003). Emission factors were originally taken from a similar model TREMOD-MM (Lambrech et al. 2004) and partially updated with data taken from (Helms et al. 2010).

Annual sales data for different types of NRMM are derived from different trade organizations such as BMWT and Federatie Agrotechniek. Fuel consumption and resulting emissions of CO, NO_x, PM and VOC are calculated using the following formula:

$$\text{Emission} = \text{Number of machines} \times \text{hours} \times \text{Load} \times \text{Power} \times \text{Emission factor} \times \text{TAF-factor} \quad (9.1)$$

In which:

- Emission = Emission or fuel consumption (grams);
- Number of machines = the number of machines of a certain year of construction with emission factors applicable to the machine's year of construction;
- Hours = the average annual running hours for this type of machinery;
- Load = the average fraction of full power used by this type of machinery;
- Power = the average full power for this type of machinery (kW);
- Emission factor = the average emission factor or specific fuel consumption belonging to the year of construction (related to emission standards, in grams/kWh);
- TAF factor = adjustment factor applied to the average emission factor to correct the deviation from the average use of this type of machine due to varying power demands.

The distribution of total fuel consumption to different economic sectors is estimated using different data sources. In order to estimate the energy use for each of the five sectors as reported in Table 9A, the different types of machinery in EMMA are distributed over these five sectors. Total fuel consumption by NRMM in the commercial and industrial sector and by households is derived directly from EMMA. Fuel consumption in agriculture and construction, as initially reported by EMMA, is adjusted. Fuel consumption by NRMM in the agricultural sector (excluding agricultural contractors) is derived from the LEI research institute of Wageningen University and Research Centre. Fuel consumption by agricultural contractors is derived from the trade organization for agricultural contractors in the Netherlands (CUMELA). Both data sources are combined to estimate total fuel consumption by mobile machinery in the agricultural sector. The difference between this total and the EMMA results for agriculture is added to the fuel consumption by construction machinery as reported by EMMA. EMMA overestimates total energy use in agriculture because in the model all agricultural machinery is reported under the agricultural sector, whereas in reality some agricultural machinery (e.g. tractors) is used in basic civil engineering.

The resulting fuel consumption in construction is subsequently adjusted to take into account the impact of economic fluctuations. Because EMMA is based on sales data and assumptions on the average annual use of the machinery, it is not able to properly take into account cyclical effects that do not only lead to fluctuations in the sales data of equipment, but also in the usage rates of the present machinery stock (i.e. the annual operational hours). The latter effect is not included in the model; therefore the EMMA results are adjusted based on economic indicators from Statistics Netherlands for the specific sectors where the machinery is used. The adjusted EMMA results are used to calculate emissions from non-road mobile machinery. The resulting fuel consumption (energy use) is also reported by Statistics Netherlands in the Energy Balance, and is included in *Table 9.1*. The annual correction factors used to adjust the energy use as reported by EMMA are shown in *Table 9.9*. *Table 9.10* shows the resulting energy use before and after the adjustment.

9.2.2 Emission Factors

The emissions of NO_x, PM₁₀, CO and VOC are calculated using detailed emission factors per machinery type, fuel type and emission legislation class. The TNO report on the EMMA model (Hulskotte and Verbeek 2009) provides the emission factors for the various technologies and the different stages in the European emission legislation for NRMM. The emission factors are linked to the different machine types per sales year. Emission factors were derived from different (literature) sources. Resulting (implied) emission factors for NO_x, PM₁₀, CO, VOC and CH₄ for the entire time series are shown in *Tables 9.2-9.6*.

PM_{2.5} emissions are derived as a fraction of PM₁₀ emissions, using the fractions shown in *Table 9.8*. NH₃ emissions are calculated using default emission factors from the EEA Emission Inventory Guidebook (EEA 2013), as shown in *Table 9.7*. Emissions from different VOC and PAH components are derived from total VOC emissions, as calculated using formula 8.1, using specific VOC and PAH profiles. By multiplying total VOC emissions with the fractions from these profiles, the emissions of individual VOC and PAH components

are estimated. The emission factors of heavy metals are assumed to be equal to emission factors of fuels delivered to road transport, as shown in *Table 3.23A* (Pulles et al. 2012).

9.2.3 Mobile machinery at container terminals

Mobile machinery used at container terminals is not included in EMMA. Energy use and resulting emissions are instead calculated in a separate model, as described in detail in Dellaert (2016). Mobile machinery typically found at container terminals are reach stackers, empty handlers, straddle carriers, tug masters, forklifts and automated guided vehicles. These machines are used to transfer containers from container ships to a storage location or another mode of transportation. Based on a study by the Joint Environmental Protection Agency Rijnmond (DCMR) into the average machinery fleet at a number of container terminals in the port of Rotterdam (Okkerse & de Gier, 2010), an average fleet composition (engine size, production year) for the Netherlands was estimated for the entire time span starting in 1990. For this purpose, a similar scrap function as included in EMMA is used to estimate the scrappage of machinery.

From the DCMR report it can be derived that the handling of containers takes approximately 4.5 litres of diesel per TEU (Twenty feet Equivalent Unit) at a typical container terminal in 2010. Using the average diesel use per delivered kWh of the machine fleet in 2010, this diesel use is converted to a measure of delivered energy/TEU. The resulting value of 14.5 kWh/TEU is kept constant over the model time range. For the handling of empty containers at container storage depots, it is estimated that fuel use is two-thirds lower, resulting in 1.5 litres per TEU. The emission factors used are based on the emission standards for non-road vehicles of the EU. The emission are then calculated using formula 9.2:

$$\text{Emission} = \text{Number of containers} \times \text{Delivered energy per container} \times \text{Emission factor} \times \text{TAF-factor} \quad (9.2)$$

In which:

- Emission = Emission or fuel consumption (grams);
- Number of containers = the number of containers handled at Dutch container terminals;
- Delivered energy per containers = the required amount of energy to handle one TEU (in kWh/TEU);
- Emission factor = the average emission factor or specific fuel consumption belonging to the year of construction (related to emission standards, in grams/kWh);
- TAF factor = adjustment factor applied to the average emission factor to correct the deviation from the average use of this type of machine due to varying power demands.

The emissions of PM_{2.5} and EC are calculated as a fraction of the PM emissions.

To estimate the total number of container handlings, a complete time series for container handlings in the port of Rotterdam is used in combination with data from the Dutch Statistical Agency.

9.3 Uncertainties

There is no recent and accurate information available for assessing the uncertainties of the emissions of air pollutants from non-road mobile machinery in the Netherlands. The uncertainties in emissions of air pollutants have been derived from the uncertainty in activity data and emission factors in accordance with the rule that the uncertainty of the product of two uncertain factors is equal to the largest uncertainty in one of the two factors, therefore:

- $A * A = A$
 - $A * B = B$
 - $B * A = B$
- etc.

The results are shown in the Appendix.

9.4 Points for improvement

The current methodology to estimate emissions from NRMM could be improved regarding:

1. The diesel used in the construction sector is liable to relatively strong economic fluctuations. At present the correction for this phenomenon takes place using economic indicators derived from Statistics Netherlands instead of physical indicators. It could be investigated if there are enterprises or institutions that have figures of diesel consumption at their disposal.
2. There is a lack of input data for several types of machinery and sectors. In the garden sector and private households weakly founded or extrapolated figures have been used to estimate the size of the fleet. With targeted research into these data relatively high figures for the VOC emissions can be replaced by improved figures.
3. The application of generic survival rates for all types of machinery might have led to declinations in the fleet composition (age profile) compared with reality in the case of certain important types of machinery, including agricultural tractors, excavators, and shovels. Investigations into the age profile and the use of the active fleet could lead to a considerable improvement of the reliability of the emission figures. In view of their relatively high number, agricultural tractors are first to be considered for further investigation.
4. The effect of varying engine loads on emissions has hardly been examined. For some types of machinery, it is of great importance to have a better knowledge of the influence on the emissions. A specific measurement programme for investigating the effect of transient engine loads in the machine's daily practice could lead to a far better foundation of the emission data.
5. Via a specific measurement scheme the effect of longer or shorter postponed maintenance on the emissions of building machinery due to highly varying hire and lease practices, as they occur in the market, could be further investigated.

10 REFERENCES

Chapter 1

- Coenen, P.W.H.G., Maas, C.W.M. van der, Zijlema, P.J., et al. (2017), Greenhouse gas emissions in the Netherlands 1990-2015. National Inventory Report 2017, National Institute for Public Health and the Environment, Bilthoven.
- IPCC (2006), 2006 IPCC Guidelines for National Greenhouse Gas Inventories, Prepared by the National Greenhouse Gas Inventories Programme, Eggleston, H.S., Buendia, L., Miwa, K., Ngara, T. and Tanabe, K. (eds). Published: IGES, Japan.
- Jimink, B.A., Coenen, P.W.H.G., Dröge, R. et al. (2017), Emissions of transboundary air pollutants from the Netherlands 1990-2015. Informative Inventory Report 2017, National Institute for Public Health and the Environment, Bilthoven.
- UNECE (2015), Guidelines for reporting emissions and projections data under the convention on long-range transboundary air pollution. ECE/EB.AIR/128, United Nations Economic Commission for Europe, United Nations, New York and Geneva.

Chapter 2

- EEA (2013) EMEP/EEA Emission Inventory Guidebook 2013, European Environmental Agency, Copenhagen.
- Gense, N.J. & Vermeulen, R.J. (2002), N₂O-emissions from passenger cars, TNO report 02.OR.VM.016.1/NG, TNO Automotive, Delft,
- Harvey, C., Carey, P. & Warila, J. (2003) EPA's newest draft nonroad emission inventory model, 12th International Emission Inventory Conference, San Diego, California.
- Hulskotte, J.H.J. (2004), Protocol voor de jaarlijkse bepaling van de emissies van specifieke defensie-activiteiten conform de IPCC-richtlijnen, TNO-rapport R2004/405 (in Dutch).
- Hulskotte J.H.J. & Verbeek R. (2009), Emissiemodel Mobiele Machines gebaseerd op machineverkoop in combinatie met brandstofafzet (EMMA), TNO-034-UT-2009-01782_RPT-ML.
- IPCC (2006), 2006 IPCC Guidelines for National Greenhouse Gas Inventories, Prepared by the National Greenhouse Gas Inventories Programme, Eggleston, H.S., Buendia, L., Miwa, K., Ngara, T. and Tanabe, K. (eds). Published: IGES, Japan.
- Kuiper, E. & Hensema, A. (2012), N₂O emissies van wegverkeer, TNO-060-DTM-2012-02977, TNO, Delft.
- NNWB (2008), Exhaust from recreational boats, Netherlands National Water Board in cooperation with Deltares and TNO.
- Riemersma, I., Jordaan, K. & Oonk, H. (2003), N₂O emissions of HD vehicles, TNO report 03.OR.VM.006/IJR, TNO Automotive, Delft.
- Stelwagen, U. & Ligterink, N.E. (2014), CO₂ emission from urea consumption in SCR after-treatment systems in heavy-duty vehicles, TNO 2014 R11513, Utrecht: TNO.
- Zijlema, P.J. (2017), The Netherlands: list of fuels and standard CO₂ emission factors, version April 2017.

Chapter 3

- Asch, R. van, Verbeek, R.P., Ligterink, N.E., Kadijk, G. (2009), Real world efficiency of retrofit partial-flow diesel particulate filters for trucks, TNO report.
- Boer, L.C. den, M.J.J. 't Hoen & M.B.J. Otten (2015), Update rekenmodule emissies autobussen. Ten behoeven van de emissieregistratie, Delft: CE Delft.
- CBSa (several volumes), Het bezit en gebruik van bedrijfsvoertuigen (ownership and use of commercial vehicles), CBS, Voorburg/Heerlen. *Discontinued*.

- CBSb (several volumes), Inkomend toerisme: toeringcarpassagiers in Nederland (coach passengers in The Netherlands). A.Maas, W.E. Bernelot Moens. Sociaal-culturele berichten 1988-3.
- CBS (1996), Mobiliteit in Nederland; Resultaten onderzoek verplaatsingsgedrag 1995, CBS, Den Haag.
- Denier van der Gon, H., Ten Broeke, H. & Hulskotte, J. (2008), Emissies door wegdekslijtage ten gevolge van het wegverkeer, Rijkswaterstaat Waterdienst.
- Dröge, R., Hensema, A., ten Broeke, H., Hulskotte, J. (2011) Emissions of two-wheeled vehicles. TNO-report TNO-060-UT-2011-01556, Utrecht.
- EEA (2007), EMEP/CORINAIR Emission Inventory Guidebook 2007. European Environment Agency, Copenhagen, Denemarken.
- EU, 2002. EU Publication sheet, C 145 E/71, 2002-6-18.
- FAPETRO (1999), Verslag van de activiteiten van het fonds voor de analyse van petroleumproducten.
- FAPETRO (2000), Verslag van de activiteiten van het fonds voor de analyse van petroleumproducten.
- Feenstra, J.F. & P.J.F. van der Most (1985), Diffuse bronnen van waterverontreiniging, IVM-rapport E85/15, Instituut voor Milieuvraagstukken (IVM), Amsterdam.
- Goudappel Coffeng (2010), Onderzoek naar de wegtypeverdeling en samenstelling van het wegverkeer. Eindrapport, Goudappel Coffeng, Deventer.
- Heeb, N.V., A.-M. Forss & M. Weilenman (2002), Pre- and post-catalyst-, fuel-, velocity- and acceleration-dependent benzene emission data of gasoline-driven Euro-2 passenger cars and light-duty vehicles, Atmospheric Environment, Vol. 26, pp. 4745-4756.
- Kadijk, G., Ligterink, N.E. & Spreen, J.S. (2015), On-road NO_x and CO₂ investigations of Euro 5 Light commercial vehicle, TNO report.
- Kampert A., Van Melis, J., Molnár-in 't Veld, H., Sijstermans, M. & Willems, R. (2014), Methodierapport verkeersprestaties speciale voertuigen, Statistics Netherlands, Den Haag/Heerlen.
- Kraan, T.C., Ligterink, N.E. & Hensema, A. (2014), Uncertainties in emissions of road traffic: Euro-4 diesel NO_x emissions as case study, TNO 2012 R11316, Delft: TNO.
- Kruiskamp, P., Molnár-in 't Veld, H., Ligterink, N. (2015), Bottom-up berekening CO₂ van bestelauto's (in Dutch). Statistics Netherlands (CBS), Den Haag/Heerlen.
- LeFranc, F. (1999), Update VERSIT light-duty vehicles, TNO Automotive, Delft.
- Ligterink, N.E. & Lange, R. de (2009), Refined vehicle and driving behaviour dependencies in the VERSIT+ emission model, ETAPP symposium.
- Ligterink, N.E., Lange, R. de, Vermeulen, R. & Dekker, H. (2009), On-road NO_x emissions of Euro-V truck, TNO report.
- Ligterink, N.E., Kadijk, G., Mensch, P. van (2012), Determination of Dutch NO_x emission factors for Euro-5 diesel passenger cars, TNO report.
- Ligterink, N.E., Kadijk, G., Mensch, P. van, Hausberger, S., Rexeis, M., (2013) Investigations and real world emission performance of Euro 6 light-duty vehicles, TNO report.
- Ligterink, N.E., Stelwagen, U. & Kuenen, J.P.P. (2014), Emission factors for alternative drivelines and alternative fuels, TNO 2014 R11309, Utrecht: TNO.
- Ligterink, N.E. (2015), Composition and payload distribution of the on-road heavy-duty fleet in the Netherlands, TNO 2016 R10040, Utrecht: TNO.
- Ligterink, N. (2016), On-road determination of average Dutch driving behavior for vehicle emissions, Delft: TNO.
- Ligterink, N. (2017), Elemental carbon emission factors of vehicles for Dutch air-quality assessments, Delft: TNO.
- Machrafi, H. & W. Mertens (1999), Verslag van het onderzoek naar het benzeen (benzene survey report), studentverslagen TU Eindhoven (Technical University).
- Molnár-in 't Veld, H. & Dohmen-Kampert, A. (2011), Verkeersprestaties autobussen; methodebeschrijving en resultaten, Statistics Netherlands, Den Haag/Heerlen.

- Molnár-in 't Veld (2014), Onderzoeksmethode berekenen verkeersprestaties van personenauto's, Statistics Netherlands, Den Haag/Heerlen.
- Molnár-in 't Veld, H., Sijstermans, M., Staats, K., et al. (2014), Methodologisch rapport verkeersprestaties motorfietsen en bromfietsen, Statistics Netherlands (CBS), Den Haag/Heerlen.
- Riemersma, I.J. & Smokers, R. (2004), Ontwikkeling van het Versit+ HD emissiemodel, TNO, Delft.
- Roovaart, J.van den (2000), Notitie over gebruik van ZOAB t.b.v. taakgroep Verkeer (memo about the use of porous asphalt), RIZA.
- RWS (2008), Remslijtage, Versie juni 2008, Rijkswaterstaat – Waterdienst in samenwerking met DELTARES en TNO.
- Shell (2000), Technical information on Shell Pura, Department of Technical Support Fuels, 2000/CSS/086.
- Staats, K., Molnár-in 't Veld, H., Willems, R. & Ligterink, N. (2014), Bottom-up berekening CO₂ personenauto's (in Dutch). Statistics Netherlands (CBS), Den Haag/Heerlen.
- Stelwagen, U. & Ligterink, N.E. (2015a), NH₃ emission factors for road transport, TNO 2015 R11005, Utrecht: TNO.
- Stelwagen, U. & Ligterink, N.E. (2015b), HD Euro-V Truck PM10 and EC emission factors, TNO 2015 R11041, Utrecht: TNO.
- Ten Broeke, H., Hulskotte, J. & Denier van der Gron, H. (2008), Emissies door bandenslijtage afkomstig van het wegverkeer, Rijkswaterstaat Waterdienst.
- Ten Broeke, H.M. & Hulskotte J.H.J. (2009), Actuele VOS- en PAK-profielen van wegverkeer, TNO-034-UT-2009-00604_RPT-ML.
- UNECE (2014), Guidelines for reporting emissions and projections data under the convention on long-range transboundary air pollution. Prepared by the task force on emission inventories and projection.
- Van Zyl, P.S., Ligterink, N.E., Kadijk, G., Borken-Kleefeld, J. & Chen, Y. (2015a), In-use compliance and deterioration of vehicle emissions, TNO 2015 R11043, Utrecht: TNO.
- Van Zyl, P.S., P. van Mensch, N.E. Ligterink, R. Dröge & G. Kadijk (2015b) Update emission model for two-wheeled mopeds, TNO 2014 R11088, Utrecht: TNO.
- VROM (1993), Publikatiereeks Emissieregistratie. Emissiefactoren Vluchtige organische stoffen uit verbrandingsmotoren, No. 10, april 1993, Den Haag.
- Weilenmann, M. (2005), Impact of Air Conditioning on Emissions of Gasoline Euro-3 Passenger Cars – Preliminary Report, EMPA, Dübendorf.
- Willems, R., Molnár-in 't Veld, H. & Ligterink, N. (2014), Bottom-up berekening CO₂ van vrachtauto's en trekkers (in Dutch). Statistics Netherlands (CBS), Den Haag/Heerlen, 2014.

Chapter 4

- Coenen, P.W.H.G. & J.H.J. Hulskotte (1998), Onderzoek naar de emissies naar oppervlaktewater van railverkeer in de provincie Zuid-Holland, rapprtnr. TNO Built Environment and Geosciences-R098/C01, TNO Built Environment and Geosciences, Apeldoorn.
- CTO, 1993, Project koperemissie spoorwegverkeer (copper emissions by rail transport), part I, II en III, Dutch Rail (NS), Centrum voor Technisch Onderzoek, Utrecht
- Ntziachristos, L., Z. Samaras, 2000. COPERT III; Computer Programme to calculate emissions from road transport, methodology and emission factors (version 2.1), European Energy Agency (EEA), Copenhagen, November 2000.
- RIVM/LAE (1993), Memo about information from Dutch Rail (NS) on emission factors for diesel powered trains, Bilthoven.
- VROM (1993), Publikatiereeks Emissieregistratie. Emissiefactoren Vluchtige organische stoffen uit verbrandingsmotoren, No. 10, april 1993, Den Haag.

Chapter 5

Bolt, E. (2003), EMS-protocol Emissies door Binnenvaart (emissions from inland navigation): Ontgassing van ladingdampen naar lucht (degassing of load vapours). Project Emissieregistratie en Monitoring Scheepvaart. Rijkswaterstaat, Adviesdienst Verkeer en Vervoer, (EMS project of Ministry of Waterways and public works) Rotterdam.

De Buck A., 't Hoen M. & den Boer E. (2013), Update estimate emissions degassing inland tank vessels, Delft: CE Delft.

Deltares & TNO (2016), Engine emissions from recreational boats (in Dutch).

Hulskotte, J. & Bolt, E. (2012), EMS-protocol Emissies door binnenvaart: verbrandingsmotoren (Emissions by inland navigation: combustion engines), versie 4.

Chapter 6

Hulskotte, J. & Koch, R. (2000), Emissiefactoren zeeschepen, TNO Built Environment and Geosciences, rapport R 2000/221, TNO, Apeldoorn.

LNV (2004), data from VIRIS (visserij registratie en informatiesysteem: Fisheries registration and information system), directorate of fisheries.

LNV (year unknown), Gids van visserijvaartuigen (guide book of fishing vessels), directorate of fisheries.

Taal, C. et al., Visserij in cijfers, annual reports 2000 – 2010 (in Dutch), LEI, Wageningen UR. Latest report published in 2011 (nr. 2010-057). ISBN 9789086153763

Chapter 7

Chiffi F., Schrooten E. & de Vlieger I. (2007), EX-TREMIS - Exploring non road Transport Emissions in Europe – Final Report. IPTS - Institute for Prospective Technological Studies. DG-JRC.

Entec (2002), Quantification of emissions from ships associated with ship movements between ports in the European Community, ENTEC Limited, July 2002.

Flodström, E. (1997), Energy and emission factors for ships in operation, KFB report 24.

Grose I. & Flaherty, J. (2007), LNG Carrier Benchmarking. LNG15 2007. Shell Global Solutions International BV.

Hulskotte, J.H.J. & Matthias V. (2013), Survey of fuel consumption of seagoing tankers at berth in Rotterdam, TNO 2013 R11287.

Hulskotte, J.H.J., Wester, B., Snijder A.M. & Matthias V. (2013), International survey of fuel consumption of seagoing ships at berth, TNO 2013 R10472.

IPCC (2006), 2006 IPCC Guidelines for National Greenhouse Gas Inventories, Prepared by the National Greenhouse Gas Inventories Programme, Eggleston, H.S., Buendia, L., Miwa, K., Ngara, T. and Tanabe, K. (eds). Published: IGES, Japan.

MARIN (2016), Sea shipping emissions 2014: Netherlands Continental Shelf, 12- mile zone, Port areas and OSPAR region II, MARIN MSCN Report No. 28771-1-MSCN=rev.2, Wageningen: MARIN.

Ntziachristos, L., Z. Samaras, 2000. COPERT III; Computer Programme to calculate emissions from road transport, methodology and emission factors (version 2.1), European Energy Agency (EEA), Copenhagen, November 2000.

UK Civil Aviation Authority (2010), ICAO Engine Emissions Databank, updated December 2010

Chapter 8

AFS. (2013). *HESSQ jaarverslag 2012*. Aircraft Fuel Supply B.V.

Agrawal et al., H. (2008). Characterization of chemical and particulate emissions from aircraft engine. *Atmospheric Environment* 41, 4380-4392.

- Amsterdam Airport Schiphol. (1990, 1995 - 2004). *Statistical Annual Review*. Amsterdam.
- CBS. (2016a). *Luchtvaart; Vliegbewegingen op Nederlandse luchthavens*. Retrieved June 2016, from CBS Statline: <http://statline.cbs.nl/>
- CBS. (2016b). *Vliegbewegingen per ICAO type Nederlandse vliegvelden*.
- EMEP/EEA. (2016). *Air pollutant emission inventory guidebook. NFR 1.A.3.a*. Copenhagen: EEA.
- Feldbrugge, P. (2014). *Personal communication in name of KES by email 30-10-2014*.
- FFA. (1996). *Federal Aviation Air Emissions Databank version 2.1*. Bromma: Aeronautical Research Institute of Sweden.
- ICAO. (2011). *Airport air quality manual*. Montreal: ICAO.
- ICAO. (2016a). *DOC 8643 - Aircraft type designators*. Retrieved June 2016, from <http://www.icao.int/publications/DOC8643/Pages/default.aspx>
- ICAO. (2016b). *Engine exhaust emissions data bank*. Paris: <https://www.easa.europa.eu/document-library/icao-aircraft-engine-emissions-databank>.
- ICAO. (several years). *International standards and recommended practices environmental protection, Annex 16 to the convention on international civil aviation. First edition 1981*. Paris: International Civil Aviation Organisation.
- KLM. (2016). *APU emission factors*. Amsterdam: KLM.
- Kugele, A., Jelinek, F., & Gaffal, R. (2005). *Aircraft particulate matter estimation through all phases of flight*. Eurocontrol EEC/SEE/2005/0014.
- Ministerie van Infrastructuur en Milieu. (2016). *Luchtvaartuigregister Nederland*.
- Morris, K. (2007). *Emissions from Aircraft; Airframe sources; Tyre and brake wear*. British Airways.
- Netcen. (2004). *Revision to the Method of Estimating Emissions from Aircraft in the UK Greenhouse Gas Inventory*. Abingdon.
- Nollet. (1993). *Taxi times for PMMS-working party 4 (revised version)*. Amsterdam: NV Schiphol Airport, AOM93/025.RH.
- Rindlisbacher et al., T. (2007). *Aircraft piston engine emissions*. Bern: Swiss Federal Office of Civil Aviation (FOCA).
- Rindlisbacher, T. (2009). *Guidance on the determination of helicopter emissions*. Federal Office Of Civil Aviation (FOCA), Swiss Confederation, Reference: 0/ 3/33/33-05-20.
- US EPA. (1985). *AP-42 Compilation of air pollution emission factors, volume 2, Mobile sources, 4th edition*. Triangle park: United States Environmental Protection Agency.
- Visschedijk, A., Appelman, W., Hulskotte, J., & Coenen, P. (2007). *Onderhoud van methodieken Emissieregistratie 2006 - 2007*. Apeldoorn: TNO.

Chapter 9

- Dellaert, S.N.C. (2016), Emissions of mobile machinery at Dutch container terminals, TNO, Utrecht.
- EEA (2013) EMEP/EEA Emission Inventory Guidebook 2013, European Environmental Agency, Copenhagen.
- Harvey, C., Carey, P. & Warila, J. (2003), EPA's newest draft nonroad emission inventory model, 12th International Emission Inventory Conference, San Diego, California.
- Helms, H. et al. (2010), Aktualisierung des Modells TREMOD- Mobile Machinery (TREMOM-MM), UBA TEXTE 28/2010, Dessau-Rosslau.
- Hulskotte J.H.J. & Verbeek R. (2009), Emissiemodel Mobiele Machines gebaseerd op machineverkopen in combinatie met brandstofafzet (EMMA), TNO-034-UT-2009-01782_RPT-ML.
- Lambrecht, U. et al. (2004), Entwicklung eines Modells zur Berechnung der Luftschadstoffemissionen und des Kraftstoffverbrauchs von Verbrennungsmotoren in mobilen Geräten und Maschinen, IFEU, Heidelberg.

Okkerse, W.J.H. & de Gier, C.W. (2010), Stikstofoxidenemissies van containerterminals, droge bulk bedrijven en bouwplaatsen in de Rotterdamse haven, Rotterdam: DCMR.

Pulles T., Denier van der Gon H., Appelman W., Verheul M. (2012), Emission factors from diesel and petrol used in European vehicles, Atmospheric Environment 61, 641-651.

11 APPENDIX: Quality codes

A. Quality coding of activity data for emissions from mobile sources

	Road transport						total
	Passenger	light	heavy	mopeds	motor-		
	Cars	commercial vehicles	commercial vehicles		cycles		
Number of vehicles	A	A	A	B	A		
Vehicle kilometres							
per year of manufacture	B	C	C	D	D		
per road type	B	C	C	D	D		
Total	A	B	B	B	B		
Fuel consumption							
specific consumption	A	B	B	C	C		
Cons. per year of manufacture	B	C	C	D	D		
cons. per road type	C	C	C	D	D		
Consumption	B	C	C	C	C		
sales (IPCC)	B	C	C	C	C		A

	Inland waterways		Seagoing shipping	Rail transport	Air transport		Mobile machinery			total
	Profes- sional	Recre- ational	(in- harbour)		Schip -hol	Other	agri- culture	con- struct.	other	
	Number of vehicles		C							
Kilometres				B						
Aircraft movements					A	B				
Vessel movements		D	C							
Fuel consumption										
specific consumption		N								
Consumption	C	D	D	B	C	C	B	D	E	E
sales (IPCC)	B			B	N		B	D	E	E

Explanation of coding (US EPA method)

A = The data originate from extremely accurate (high precision) measurements.

B = The data originate from accurate measurements.

C = The data originate from a published source, such as government statistics or industrial trade figures.

D = The data are generated by extrapolating other measured activities.

E = The data are generated by extrapolating data from other countries.

N = Not applicable or unknown.

B. Quality coding of emission factors for mobile sources

	Road transport						total			
	passenger cars	light commercial vehicles	heavy commercial vehicles	mopeds	motor-cycles					
Combustion emissions										
CO/VOC total	C	C	C	D	D					
NO _x	B	B	B	D	D					
PM ₁₀	C	C	C	E	E					
N ₂ O	C	C	D	E	E					
SO ₂	C	C	C	C	C	C	C			
CO ₂	A	A	A	A	A	A	A			
VOC/PAH profiles	D	D	D	D	D	D	D			
Dioxins	E	E	E	E	E	E	E			
Metals	D	D	D	D	D	D	D			
Evaporative emissions										
Total	D	D	D	D	D					
VOC profile	D	D	D	D	D		D			
Other emissions										
tyre wear particles, PM ₁₀	E	E	E	E	E					
tyre wear debris, metals	E	E	E	E	E					
brake lining wear debris, PM ₁₀	E	E	E	E	E					
brake lining wear debris, metals	E	E	E	E	E					
road wear debris, PM ₁₀	E	E	E	E	E					
road wear debris, metals	E	E	E	E	E					
road wear debris, PAH	E	E	E	E	E					
leakage losses motor oil	E	E	E	E	E		E			
consumption motor oil, metals	E	E	E	E	E					
Other factors										
Ageing	N	N	N	N	N					
cold start	D	D	D	D	D					
driving behaviour	N	N	N	N	N					
Accessories	N	N	N	N	N					
ageing canister	N	N								
Allocated to compartment										
combustion emissions	E	E	E	E	E		E			
wear debris tyres, etc.	E	E	E	E	E		E			
oil leakage	E	E	E	E	E		E			
<hr/>										
	Inland waterways		Seagoing	Rail	Air transport		Mobile machinery		total	
	profess- ional	recre- ational	shipping (in- harbour)	transpo rt	Schip- hol	Other	agri- culture	constr.		other
Combustion emissions										
CO/VOC total	C	D	C	D	C	D	D	D	D	D
NO _x	B	D	C	C	B	C	D	D	D	D
PM ₁₀	D	E	E	E	E	E	E	E	E	E
N ₂ O	E	E	E	E	E	E	E	E	E	E
SO ₂	A	A	C	A	C	C	A	A	A	A
CO ₂	A	A	A	A	A	A	A	A	A	A
VOC/PAH profiles	D	D	D	D	D	D	D	D	D	D
Dioxins	E	E	E	E	E	E	E	E	E	E
Metals	D	D	D	D	D	D	D	D	D	D
Evaporative emissions										
Total	N	D	N	N						N
VOC profile	N	D	N	N						N
wear overhead contact lines				C						
Allocated to compartment										
Combustion emissions	E	E	E	E						
wear overhead contact lines				E						

C. Quality coding of emissions from mobile sources

		Road transport					
		passenger cars	light commercial vehicles	heavy commercial vehicles	mopeds	motor-cycles	Total
Combustion							
CO/VOC	total	C	C	C	D	D	C
	per year of manufacture	C	C	C	D	D	
	per road type	C	C	C	D	D	C
NO _x	total	B	B	B	D	D	B
	per year of manufacture	B	C	C	D	D	
	per road type	B	C	C	D	D	C
PM ₁₀	total	C	C	C	E	E	C
	per year of manufacture	C	C	C	E	E	
	per road type	C	C	C	E	E	C
N ₂ O	total	E	E	E	E	E	E
NH ₃	total	E	E	E	E	E	E
CH ₄	total	D	D	D	D	D	D
SO ₂	total	B	C	C	C	C	B
	per year of manufacture	B	C	C	D	D	
	per road type	C	C	C	D	D	C
CO ₂ (NL territory)	total	B	C	C	C	C	B
	per year of manufacture	B	C	C	D	D	
	per road type	C	C	C	D	D	C
CO ₂ (IPCC)	total	B	C	C	C	C	A
VOC/PAH comp.	total	D	D	D	D	D	D
Metals	total	D	D	D	D	D	D
Evaporation							
	total	D	D	D	D	D	D
	VOC components	D	D	D	D	D	D
Other							
tyre wear debris, PM ₁₀	total	E	E	E	E	E	E
	to compartment	E	E	E	E	E	E
tyre wear debris, metals	total	E	E	E	E	E	E
	to compartment	E	E	E	E	E	E
brake wear debris, PM ₁₀	total	E	E	E	E	E	E
	to compartment	E	E	E	E	E	E
brake wear debris, metals	total	E	E	E	E	E	E
	to compartment	E	E	E	E	E	E
Road wear debris, PM ₁₀	total	E	E	E	E	E	E
	to compartment	E	E	E	E	E	E
Road wear debris, metals	total	E	E	E	E	E	E
	to compartment	E	E	E	E	E	E
road wear debris, PAH	total	E	E	E	E	E	E
	to compartment	E	E	E	E	E	E
leakage losses motor oil	total	E	E	E	E	E	E
	to compartment	E	E	E	E	E	E
combust. motor oil, metals	total	E	E	E	E	E	E
	to compartment	E	E	E	E	E	E

C. Quality coding of emissions from mobile sources (continuation)

	Inland waterways professional	recreational	Seagoing shipping (in- harbour)	Rail transport Schip- hol	Air transport Other	Mobile machinery					Total Transport and transport
						agri- culture	constr.	other	total		
Combustion											
CO/VOC	C	D	D	D	C	D	D	D	E	E	C
NO _x	C	D	D	C	B	C	D	D	E	E	C
PM ₁₀	D	E	E	E	E	E	E	E	E	E	D
N ₂ O	E	E	E	E	E	E	E	E	E	E	E
NH ₃	E	E	E	E	E	E	E	E	E	E	E
CH ₄	D	D	D	D	D	D	D	D	E	E	D
SO ₂	C	D	D	B	C	C	B	D	E	E	C
CO ₂ (NL territory)	C	D	D	B	C	C	B	D	E	E	B
CO ₂ (IPCC)	B			B			B	D	E	E	B
VOC/PAH components	D	D	D	D	D	D	D	D	E	E	D
Metals	D	D	D	D	D	D	D	D	E	E	D
Evaporation											
VOC components		D									
		D									
Wear											
Overhead contact lines to compartment				C							
				E							